

NUT COVER & WHEEL PRODUCT CATALOG

2ND EDITION



Quality.

Innovation.

Design.

MISSION STATEMENT

Here at United Pacific, we are dedicated to providing today's drivers with innovative and exciting products that deliver exceptional performance and value. Because United Pacific's continuing success depends on our customer's satisfaction, we constantly push our designers and engineers to upgrade our facilities and processes in order to bring products of superior quality and reliability to the market. We at United Pacific promise to continue our passionate pursuit to be the first in

QUALITY, INNOVATION AND DESIGN.

QUALITY

With over 30 years of experience in the heavy duty trucking industry, United Pacific Industries understand the rigors and stresses that our products are subjected to on the road. It is our mission to provide our customers with products of superior quality and reliability. In achieving this goal, United Pacific only partners with manufacturing facilities that conforms to our quality control requirements and standards. Our manufacturing partners meet or exceed ISO-9001 requirements. In addition, United Pacific's manufacturing partners must be equipped on site to perform the following quality assurance tests:

AGING TEST

AIR TIGHT TEST

DUST TEST

FLUX TEST

PHOTOMETRIC TEST

PULL FORCE TEST

RAIN TEST

SALT SPRAY TEST

SHOCK TEST

TEMPERATURE TEST

HUMIDITY TEST

VIBRATION TEST

United Pacific's manufacturing partners must maintain a track record of consistent quality and low product failure rate. Furthermore, our internal quality control structure allows us to function as the final quality control station prior to shipping. With the assistance of 3D computer technology, United Pacific can adhere to strict quality control standards during prototype creation and the production process. Our engineers and technicians perform a battery of tests to ensure that our products meet the demands of today's drivers and our goal to be first in quality.

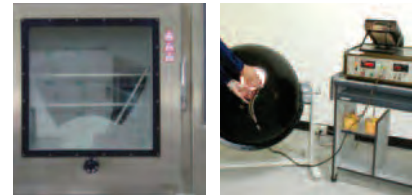
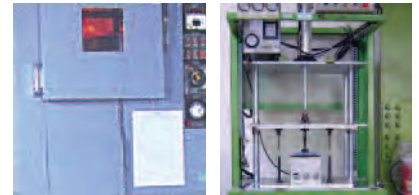



HOW TO ORDER

To order from United Pacific Industries, you must be an authorized dealer, distributor or OEM.

If you are not authorized to stock and sell United Pacific products, you must order through an authorized dealer. Please call 1 (310) 638-5988 for more information.

CONTACT US

United Pacific customer service representatives are available from:

8 am - 4:30 pm PST

Toll Free: 1 (800) 790-6988
Phone: 1 (310) 638-5988
Fax: 1 (310) 638-6287
Email: sales@uapac.com
Website: www.uapac.com

INNOVATION

Known as the leader in innovation, United Pacific is dedicated to be the first to bring new and exciting products to the market. United Pacific's global expertise allows us to search the globe for new ideas and concepts. Not only do we search the globe for new products, United Pacific invest a significant amount of resources into our own research and development efforts.



With the assistance of advance 3D scanning technology, our engineers and designers can acquire accurate and precise data in seconds. The 3D data allows United Pacific to verify designs, perform quality assurance tests, and reverse engineer with unprecedented speed and accuracy. Digital inspection contributes to the early detection of shape problems, provides rapid feedback on design, and eliminates unnecessary work in downstream processes. Our rapid prototyping facility permits us to have a concept-to-shelf time of less than 5 months.



In addition, United Pacific's 3D printing capabilities permit our designers to have physical models of their design concepts in hours. The physical models allow our designers and marketing staff to evaluate and test the viability of different design ideas. Our rapid prototyping facility allow United Pacific to compress design cycles, improve manufacturing planning, shorten concept-to-shelf time, most importantly, generate new and innovative products.

DESIGN

Located near some of the nation's most progressive automotive design centers, United Pacific established the UP Design Studio in 2002 to consolidate our position as the design leader in the heavy duty trucking industry. UP Design Studio utilizes the latest generation of computer aided design (CAD) and studio/graphic softwares. The design studio is equipped with the newest computers and rapid prototyping systems. In addition, UP Design Studio is staff by graduates from the nation's most prestigious design colleges.



Unlike our competitors, United Pacific's design and manufacturing capabilities mean that we carry more new and original items than our competitors. The establishment of the design studio will enable us to generate even more new products with significant shorter concept-to-shelf time. The reduction in development cost mean that we can develop products utilizing design based development processes. Design based product development allows United Pacific to create new product concepts base on designs incorporating driver demands and needs instead of economic considerations. United Pacific's emphasis on design distinguishes and positions us ahead of our competitors.



Light Emitting Diodes (LED)

Low voltage Operation

A low voltage device, LEDs draw minuscule amount of current from a vehicle's electrical system compare to incandescent devices. Low voltage draw protects and prolongs a vehicle's electrical system.

Instant On

LEDs light up in microseconds. Research conducted by University of Michigan Transportation Research Institute indicates that motorist respond quicker to LEDs than incandescent lights.

Rugged & Durable

Being a solid-state device, LEDs contain no moving parts and filaments to break. Produced with similar technologies as the latest microprocessor, LEDs provide unparalleled reliability and dependability.

Cold Start Capacity

Unlike many light sources in use today, LEDs do not require any special drivers or equipment to operate in extreme cold temperature. Solid State technology allows LEDs to function in inhospitable environments, down to -40°.

WARRANTY

With LEDs (Light Emitting Diodes) rated at 100,000 hour of operation and solid-state construction, United Pacific's LED lights are extremely reliable and durable. United Pacific offers a 10 Year Limited Warranty on most LED lights. Economy LED lights are only covered by a 2 Year Limited Warranty. All LED accessory lights are covered by a 6 Month Limited Warranty.



INVENTORY & SHIPPING

With over \$5.8 million in inventory, United Pacific carries over 8,000 items in our California distribution center. No other company in the heavy duty trucking industry can match United Pacific in the variety and range of in-stock inventories. With an order fill rate of over 98.5%, United Pacific is the largest and most reliable supplier in the industry. Our shipping department ships 96.8% of all orders within 24 hours and 98.9% within 48 hours. United Pacific's vast inventory and prompt shipping has made United Pacific the only source for our customer's chrome and lighting needs.

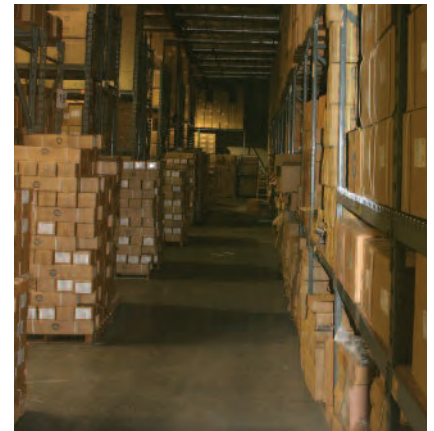

ASSEMBLED IN U.S.A

United Pacific strives to provide today's drivers with innovative and exciting products that deliver exceptional performance and value. With our international background and expertise, we search the globe for the best and most reliable products. However, as an American company, we believe and support the American way of life. Look for the "Assembled in the USA" label on many of our products. Although the components are manufactured overseas, the products, bearing the "Assembled in the USA" labels, are hand assembled with pride in the United States.



WEBSITE

United Pacific strives constantly to improve our existing facilities and procedures. As a part of our continuous improvement process, United Pacific will soon be updating our website. The new website will be even more comprehensive and in-depth. In addition, we will incorporate an online ordering system that will enable our customer to order and receive shipping updates online. The online ordering system will only be available to authorized retailers. The new website is just another example of United Pacific's ceaseless pursuit to be our customer's only source for their chrome and lighting needs.



Hard at work for our customers

UNITED PACIFIC SHANGHAI

In 2005, United Pacific opened United Pacific Shanghai. Staffed with 3 quality assessment engineers and 2 logistic support personnel, United Pacific Shanghai serves as United Pacific's quality control and logistics office in China. Located in the commercial center of China, the Shanghai office provides United Pacific with unparalleled access to local markets and suppliers. The open access translates into faster product development and more rigorous quality control standards. The opening of the Shanghai office means that there will be a United Pacific employee hard at work for our customers 24 hours a day in different parts of the world.

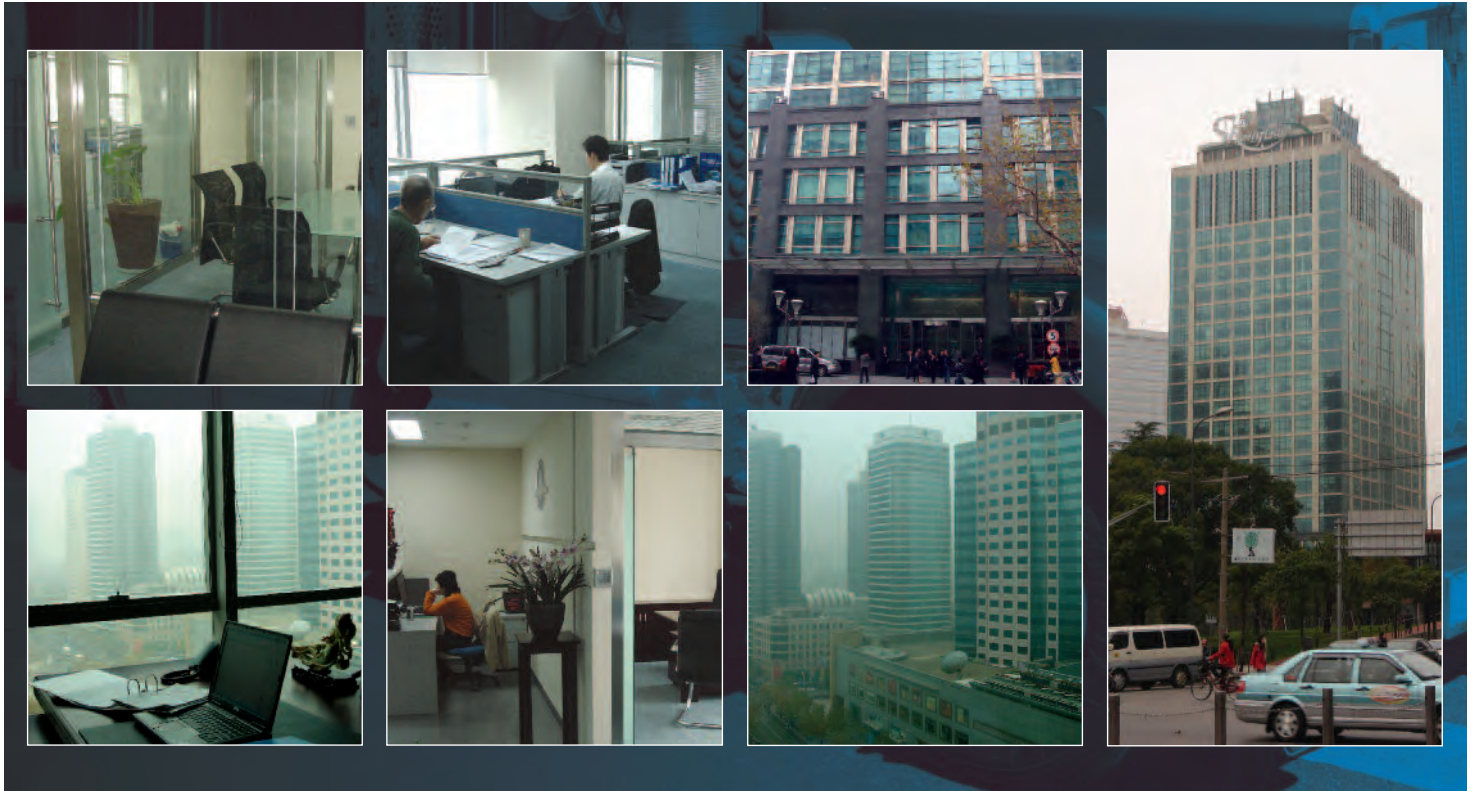

UNITED PACIFIC CHROME PLATING

United Pacific's commitment to quality led United Pacific to invest in its own chrome plating facility. With one chrome plating line fully operational and another in construction, the chrome plating plant will ensure that United Pacific products meet our strict quality control standards. Better products mean better sales for United Pacific customers.

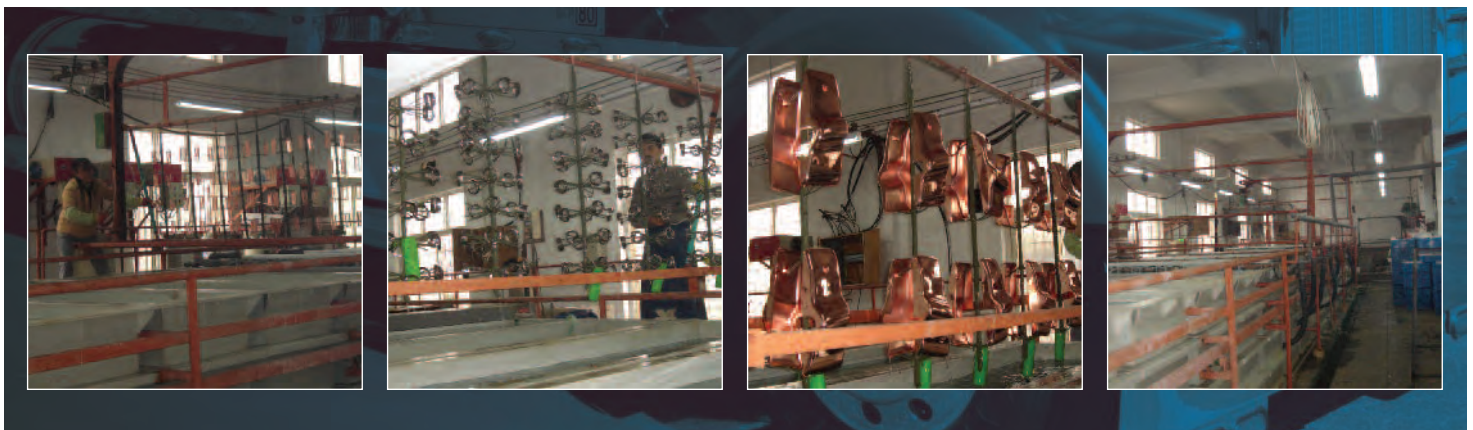

Hard at work for our customers

UNITED PACIFIC JOINT VENTURE

Here at United Pacific, collaboration is at the heart of our business. We partner with manufacturers that are as passionate about well-made and well-designed products as we are. In 2006, United Pacific entered into the ultimate collaboration. United Pacific formed a joint venture with China's largest manufacturer of heavy duty trucking products. The joint venture currently supplies all major American and Canadian aftermarket distributors (including United Pacific competitors) with stainless steel, chrome, and exhaust products. Because of our collaborative approach to product development and manufacturing, we're able to eliminate undue inefficiencies and cost. As a result, United Pacific customers benefit from unique products that are offered at the best possible price and the highest possible quality.



TABLE OF CONTENTS

NUT COVERS & ACCESSORIES		PAGE
Steel Nut Cover		
Chrome Nut Cover		2
Stainless Steel Nut Cover		3
Gold Nut Cover		3
Reflector Nut Cover		4
Die-Cast Nut Cover		
Chrome Die-Cast Nut Cover		4
Chrome Plastic Nut Cover		
Push-On Nut Cover		5
Thread-On Nut Cover		8
Nut Cover Accessories		9
“Huck” Bolt Cover		
Freightliner “Huck” Cover		9
International “Huck” Cover		9
Specialty Nut Cover		
Full Size Pick Up Nut Cover		10
Snap Caps		10
Phillips Screw Cover		10
HUB CAP ACCESSORIES		PAGE
Front Hub Caps		
Front Hub Cap		11
Front Hub Cap with Spinner		13
Rear Hub Caps		
Rear Hub Cap		16
Rear Hub Cap with Spinner		17
Trailer Hub Caps and Brackets		
Trailer Hub Cap and Brackets		18
FRONT & REAR AXLE COVER		PAGE
Chrome Plastic Axle Cover		
Chrome Plastic Front and Rear Axle Cover		19
Chrome Plastic Axle Cover Accessories		20
Chrome Steel Front Axle Cover		
Front 2 Piece Axle Cover		22
Front 3 Piece Axle Cover		23
Chrome Steel Rear Axle Cover		
Rear 2 Piece Axle Cover		25
Rear 3 Piece Axle Cover		27
Unitized Rear Axle Cover		29
Beauty Rings		
Beauty Ring		30
Wheel Simulators		
Front Wheel Simulators		31
Rear Wheel Simulators		33
REFERENCE		PAGE
Warranty and Terms		36
Product Index		40

NUT COVERS & ACCESSORIES

Chrome Nut Cover - Steel

Description

- Chrome Plated Steel Nut Covers
- Available in Bulk (500 Pcs./Case or 1000 Pcs./Case) or 10 Piece Display Pack

33 mm Chrome Nut Cover

Item Number	Size	Height	Shape	Flange	Pack
10031	33 mm	2"	Standard	Yes	500/Case
10031P	33 mm	2"	Standard	Yes	10 Pcs./Pack
10005	33 mm	2 1/8"	Bullet	Yes	500/Case
10005P	33 mm	2 1/8"	Bullet	Yes	10 Pcs./Pack
10700	33 mm	2"	Nipple	Yes	500/Case
10700P	33 mm	2"	Nipple	Yes	10 Pcs./Pack
10048	33 mm	2 3/8"	Pointed	Yes	500/Case
10032C	33 mm	2"	Tall	Yes	500/Case



10031
Standard with Flange



10001
Standard



10005
Bullet with Flange



10004
Bullet

32 mm Chrome Nut Cover

Item Number	Size	Height	Shape	Flange	Pack
10043	32 mm	2"	Tall	Yes	500/Case
10043P	32 mm	2"	Tall	Yes	10 Pcs./Pack

30 mm Chrome Nut Cover

Item Number	Size	Height	Shape	Flange	Pack
10044	30 mm	2"	Tall	Yes	500/Case
10044P	30 mm	2"	Tall	Yes	10 Pcs./Pack

1 1/2" Chrome Nut Cover

Item Number	Size	Height	Shape	Flange	Pack
10001	1 1/2"	1 1/2"	Standard	No	500/Case
10002C	1 1/2"	2"	Standard	Yes	500/Case
10002CP	1 1/2"	2"	Standard	Yes	10 Pcs./Pack
10004	1 1/2"	2"	Bullet	No	500/Case
10004P	1 1/2"	2"	Bullet	No	10 Pcs./Pack
10003	1 1/2"	2 1/4"	Pointed	No	500/Case
10003P	1 1/2"	2 1/4"	Pointed	No	10 Pcs./Pack
10006	1 1/2"	2 1/4"	Bullet	No	500/Case
10006P	1 1/2"	2 1/4"	Bullet	No	10 Pcs./Pack



10700
Nipple with Flange



10048
Pointed with Flange



10003
Pointed

1 1/4" Chrome Nut Cover

Item Number	Size	Height	Shape	Flange	Pack
10008	1 1/4"	1 3/8"	Standard	No	500/Case
10008P	1 1/4"	1 3/8"	Standard	No	10 Pcs./Pack
10009	1 1/4"	2"	Standard	Yes	500/Case
10009P	1 1/4"	2"	Standard	Yes	10 Pcs./Pack



10032
Tall with Flange



Size denotes the size of the nut that the Nut Cover fits over.

Chrome Nut Cover - Steel

Description

- Chrome Plated Steel Nut Covers
- Available in Bulk (1000 Pcs./Case) or 10 Piece Display Pack

1 1/8" Chrome Nut Cover

Item Number	Size	Height	Shape	Flange	Pack
10010	1 1/8"	1 1/4"	Standard	No	1000/Case
10010P	1 1/8"	1 1/4"	Standard	No	10 Pcs./Pack

1 1/16" Chrome Nut Cover

Item Number	Size	Height	Shape	Flange	Pack
10012	1 1/16"	1 1/8"	Standard	No	500/Case
10012P	1 1/16"	1 1/8"	Standard	No	10 Pcs./Pack

1" Chrome Nut Cover

Item Number	Size	Height	Shape	Flange	Pack
10157	1"	1 1/4"	Standard	No	1000/Case

15/16" Chrome Nut Cover

Item Number	Size	Height	Shape	Flange	Pack
10015	15/16"	1 1/4"	Standard	No	1000/Case
10015P	15/16"	1 1/4"	Standard	No	10 Pcs./Pack
10015C *	15/16"	1 1/4"	Standard	No	500/Case
10015CP *	15/16"	1 1/4"	Standard	No	10 Pcs./Pack

13/16" Chrome Nut Cover

Item Number	Size	Height	Shape	Flange	Pack
10017	13/16"	1 1/8"	Standard	No	1000/Case
10017P	13/16"	1 1/8"	Standard	No	10 Pcs./Pack

3/4" Chrome Nut Cover

Item Number	Size	Height	Shape	Flange	Pack
10018	3/4"	11/16"	Standard	No	2500/Case
10018P	3/4"	11/16"	Standard	No	10 Pcs./Pack
10019	3/4"	13/16"	Standard	Yes	1000/Case
10019P	3/4"	13/16"	Standard	Yes	10 Pcs./Pack

* Item Number with " *" Denotes Economy Nut Cover



Stainless Steel Nut Cover

Description

- Stainless Steel Nut Cover, Available in Bulk (500 Pcs./Case) or 10 Piece Display Pack

33 mm Stainless Steel Nut Cover

Item Number	Size	Height	Shape	Flange	Pack
10081	33 mm	2 1/8"	Standard	Yes	500/Case
10081P	33 mm	2 1/8"	Standard	Yes	10 Pcs./Pack
10083	33 mm	2 3/8"	Pointed	Yes	500/Case
10083P	33 mm	2 3/8"	Pointed	Yes	10 Pcs./Pack

1 1/2" Stainless Steel Nut Cover

Item Number	Size	Height	Shape	Flange	Pack
10080	1 1/2"	2"	Bullet	No	500/Case
10080P	1 1/2"	2"	Bullet	No	10 Pcs./Pack

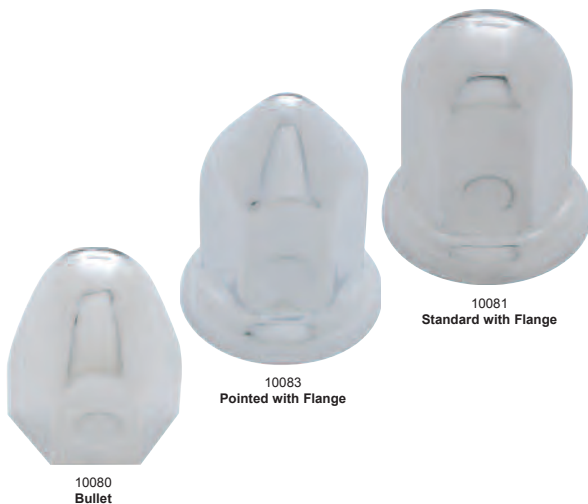

Gold Nut Cover

Description

- Gold Steel Nut Cover, Available in Bulk (500 Pcs./Case) or 10 Piece Display Pack

1 1/2" Gold Nut Cover

Item Number	Size	Height	Shape	Flange	Pack
10035	1 1/2"	1 1/2"	Standard	No	500/Case
10035P	1 1/2"	1 1/2"	Standard	No	10 Pcs./Pack

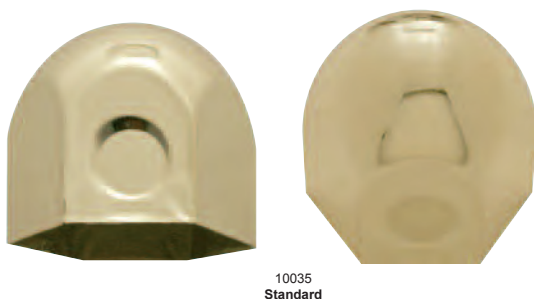

Chrome Nut Cover - Reflector

Description

- Available for 33mm and 1 1/2" Nut, Reflector Available in 5 Different Colors

33 mm Chrome Nut Cover - Reflector

Item Number	Size	Height	Color	Flange	Pack
10038	33 mm	2"	Amber	Yes	500/Case
10041	33 mm	2"	Blue	Yes	500/Case
10040	33 mm	2"	Purple	Yes	500/Case
10039	33 mm	2"	Red	Yes	500/Case

1 1/2" Chrome Nut Cover - Reflector

Item Number	Size	Height	Color	Flange	Pack
10027	1 1/2"	2"	Amber	No	500/Case
10235	1 1/2"	1 13/16"	Amber	No	500/Case
10236	1 1/2"	1 5/8"	Amber	No	500/Case
10030	1 1/2"	2"	Blue	No	500/Case
10033	1 1/2"	2"	Green	No	500/Case
10028	1 1/2"	2"	Red	No	500/Case
10237	1 1/2"	1 5/8"	Red	No	500/Case

**Chrome Nut Cover - Die Cast**

Description

- Chrome Die Cast Nut Cover, Available in 7 Different Sizes

3/4" Chrome Die Cast Nut Cover

Item Number	Size	Height	Shape	Flange	Pack
10020	3/4"	15/16"	Acorn	No	1000/Case

11/16" Chrome Die Cast Nut Cover

Item Number	Size	Height	Shape	Flange	Pack
10021	11/16"	7/8"	Acorn	No	1000/Case

5/8" Chrome Die Cast Nut Cover

Item Number	Size	Height	Shape	Flange	Pack
10022	5/8"	3/4"	Acorn	No	500/Case

9/16" Chrome Die Cast Nut Cover

Item Number	Size	Height	Shape	Flange	Pack
10023	9/16"	11/16"	Acorn	No	500/Case

1/2" Chrome Die Cast Nut Cover

Item Number	Size	Height	Shape	Flange	Pack
10024	1/2"	11/16"	Acorn	No	500/Case

7/16" Chrome Die Cast Nut Cover

Item Number	Size	Height	Shape	Flange	Pack
10025	7/16"	5/8"	Acorn	No	500/Case

3/8" Chrome Die Cast Nut Cover

Item Number	Size	Height	Shape	Flange	Pack
10026	3/8"	5/8"	Acorn	No	2500/Case

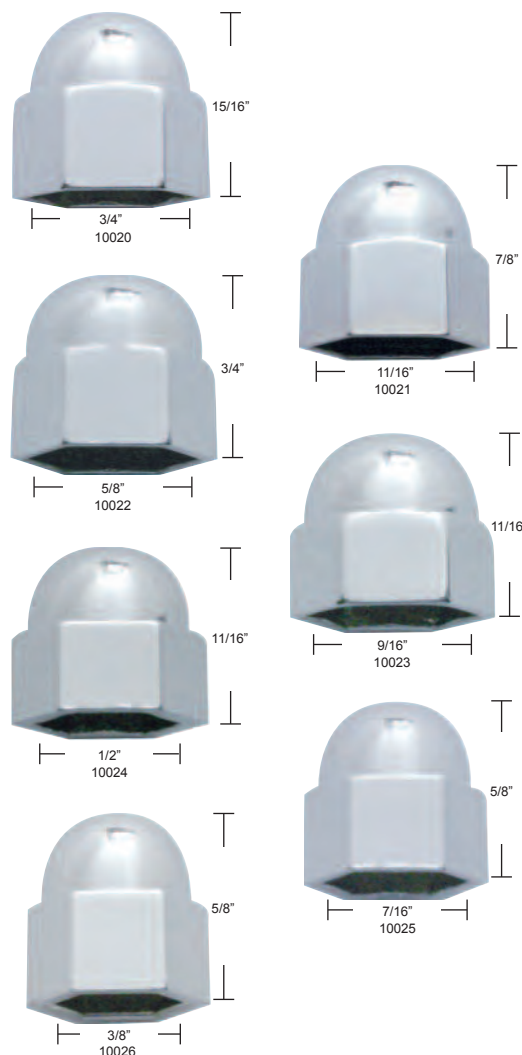

CHROME PLASTIC NUT COVER



10057



10058

Standard Nut Cover - Push-On

Description

- Chrome Plastic Standard Push-On Nut Cover for Hex Nuts and Bolts
- Available in Various Sizes

Item Number	Size	Height	Flange	Pack
10058	33 mm	2 7/16"	Yes	20 Pcs./Pack
10058B	33 mm	2 7/16"	Yes	600/Case
10057	1 1/2"	2 1/4"	No	20 Pcs./Pack
10057B	1 1/2"	2 1/4"	No	500/Case



10075



10060



10049



10061



10046



10045



10076



10062



10047



10065



10063



10069

Bullet Nut Cover - Push-On

Description

- Chrome Plastic Bullet Push-On Nut Cover for Hex Nuts and Bolts
- Available in Various Sizes

Item Number	Size	Height	Flange	Pack
10060	33 mm	2 5/8"	Yes	20 Pcs./Pack
10060B	33 mm	2 5/8"	Yes	500/Case
10049	33 mm	2 3/4"	Yes	20 Pcs./Pack
10049B	33 mm	2 3/4"	Yes	500/Case
10075	33 mm	2 3/8"	Yes	20 Pcs./Pack
10075B	33 mm	2 3/8"	Yes	600/Case
10045	1 1/2"	2 3/4"	No	20 Pcs./Pack
10045B	1 1/2"	2 3/4"	No	400/Case
10046	1 1/2"	2 3/4"	Yes	20 Pcs./Pack
10046B	1 1/2"	2 3/4"	Yes	500/Case
10061	1 1/2"	2 3/4"	Yes	20 Pcs./Pack
10061B	1 1/2"	2 3/4"	Yes	500/Case
10047	1 1/2"	2 3/4"	No	20 Pcs./Pack
10047B	1 1/2"	2 3/4"	No	500/Case
10062	1"	1 5/8"	No	1000/Case
10062P	1"	1 5/8"	No	10 Pcs./Pack
10076	15/16"	1 5/8"	No	500/Case
10076P	15/16"	1 5/8"	No	10 Pcs./Pack
10069	3/4"	1 3/8"	No	200/Case
10063	11/16"	1 5/16"	No	1500/Case
10065	9/16"	1 5/16"	No	500/Case
10065P	9/16"	1 5/16"	No	10 Pcs./Pack
10066	1/2"	1 5/16"	No	4000/Case
10066P	1/2"	1 5/16"	No	10 Pcs./Pack
10067	7/16"	3/4"	No	6000/Case
10067P	7/16"	3/4"	No	10 Pcs./Pack



10084



10089 - Spinner Top



10059

Tall Nut Cover - Push-On

Description

- Chrome Plastic Tall Push-On Nut Cover for Hex Nuts and Bolts
- Available in Various Sizes

Item Number	Size	Height	Flange	Pack
10059	33 mm	3 1/4"	Yes	20 Pcs./Pack
10059B	33 mm	3 1/4"	Yes	500/Case
10089	33 mm	3 1/4"	Yes	500/Case
10084	1 1/2"	2 3/4"	No	20 Pcs./Pack
10084B	1 1/2"	2 3/4"	No	500/Case

Pointed Nut Cover - Push-On

Description

- Chrome Plastic Pointed Push-On Nut Cover for Hex Nuts and Bolts
- Available in Various Sizes

Item Number	Size	Height	Flange	Pack
10117	33 mm	3 3/16"	Yes	20 Pcs./Pack
10117B	33 mm	3 3/16"	Yes	500/Case
10771	33 mm	2 1/4"	Yes	10 Pcs./Pack
10771B	33 mm	2 1/4"	Yes	500/Case
10092	33 mm	1 7/8"	No	500/Case
10092P	33 mm	1 7/8"	No	10 Pcs./Pack
10093	33 mm	1 7/8"	No	1000/Case
10093P	33 mm	1 7/8"	No	10 Pcs./Pack
10011	1 1/2"	3"	No	20 Pcs./Pack
10011B	1 1/2"	3"	No	500/Case
10091	1 1/8"	1 7/8"	No	1000/Case
10091P	1 1/8"	1 7/8"	No	10 Pcs./Pack
10090	15/16"	1 1/2"	No	500/Case
10090P	15/16"	1 1/2"	No	10 Pcs./Pack
10068	3/4"	1 1/2"	No	1000/Case
10068P	3/4"	1 1/2"	No	10 Pcs./Pack
10082	3/4"	7/8"	No	2000/Case
10082P	3/4"	7/8"	No	10 Pcs./Pack
10087	5/8"	1 1/4"	No	2000/Case
10088	11/16"	1 1/4"	No	2000/Case
10086	9/16"	7/8"	No	4000/Case
10086P	9/16"	7/8"	No	10 Pcs./Pack
10078	1/2"	7/8"	No	5000/Case
10078P	1/2"	7/8"	No	10 Pcs./Pack
10077	7/16"	3/4"	No	5000/Case
10077P	7/16"	3/4"	No	10 Pcs./Pack

**Flat Top Nut Cover - Push-On**

Description

- Chrome Plastic Flat Top Push-On Nut Cover for Hex Nuts and Bolts
- Available in Various Sizes

Item Number	Size	Height	Flange	Pack
10772	33 mm	2"	Yes	20 Pcs./Pack
10759	33 mm	1 5/8"	No	10 Pcs./Pack
10759B	33 mm	1 5/8"	No	500/Case
10758B	1 1/8"	1 1/2"	No	500/Case
10774B	1 3/16"	1 5/8"	Yes	1000/Case
10757	15/16"	1 1/4"	No	10 Pcs./Pack
10757B	15/16"	1 1/4"	No	2500/Case
10756	3/4"	1 1/4"	No	10 Pcs./Pack
10756B	3/4"	1 1/4"	No	1000/Case
10755	3/4"	5/8"	No	10 Pcs./Pack
10755B	3/4"	5/8"	No	2500/Case
10754	11/16"	1"	No	10 Pcs./Pack
10754B	11/16"	1"	No	2500/Case
10753B	5/8"	1"	No	2000/Case
10752	9/16"	11/16"	No	10 Pcs./Pack
10752B	9/16"	11/16"	No	4000/Case
10751	1/2"	5/8"	No	10 Pcs./Pack
10751B	1/2"	5/8"	No	5000/Case
10750	7/16"	1/2"	No	10 Pcs./Pack
10750B	7/16"	1/2"	No	5000/Case



Flange nut cover will fit over lug nuts with integrated flange washer base

Designer Plastic Nut Cover - Push-On

Description

- Chrome Plastic Push-On Nut Covers
- Available in Various Sizes and Styles
- Designer Nut Covers are Flanged to Cover Up the Flange on the 33 mm Nut

Item Number	Size	Height	Shape	Pack
10570B	33 mm	4 7/8"	Super Spike	400/Case
10566B	33 mm	4 1/4"	Spike	500/Case
10567B	33 mm	4 1/4"	Stiletto	500/Case
10568B	33 mm	3 1/2"	Cylinder	500/Case
10265	33 mm	2 3/4"	Original	400/Case
10726B	1 1/2"	4 3/8"	Razor	500/Case
10770	1 1/2"	4 1/4"	Spike	10 Pcs./Pack
10770B	1 1/2"	4 1/4"	Spike	500/Case
10779	1 1/2"	4 1/4"	Stiletto	10 Pcs./Pack
10779B	1 1/2"	4 1/4"	Stiletto	500/Case



10570B
Super Spike



10770B
Spike



10779B
Stiletto



10726B
Razor



10568B
Cylinder



10265
Original

Chrome Plastic Nut Cover - Push-On/Reflector

Description

- 33mm Chrome Plastic Push-On Nut Cover with Reflector and Flange
- Available with 5 Different Color Reflectors

Item Number	Size	Height	Color	Pack
10070	33 mm	2 3/4"	Amber	20 Pcs./Pack
10073	33 mm	2 3/4"	Blue	20 Pcs./Pack
10072	33 mm	2 3/4"	Purple	20 Pcs./Pack
10071	33 mm	2 3/4"	Red	20 Pcs./Pack



10070



10073



10072



10071

Spike Nut Cover - Push-On

Description

- Chrome Plastic Spike Push-On Nut Cover for Hex Nuts and Bolts
- Available in Various Sizes

Item Number	Size	Height	Flange	Pack
10769	33 mm	3 1/8"	No	20 Pcs./Pack
10769B	33 mm	3 1/8"	No	500/Case
10566B	33 mm	4 1/4"	Yes	500/Case
10770	1 1/2"	4 1/4"	Yes	10 Pcs./Pack
10770B	1 1/2"	4 1/4"	Yes	500/Case
10768	1 1/8"	2 13/16"	No	10 Pcs./Pack
10768B	1 1/8"	2 13/16"	No	500/Case
10767B	15/16"	2 1/2"	No	1000/Case
10766	3/4"	2 5/16"	No	10 Pcs./Pack
10766B	3/4"	2 5/16"	No	1000/Case
10765B	3/4"	1 7/8"	No	4000/Case
10764	11/16"	2 1/16"	No	10 Pcs./Pack
10764B	11/16"	2 1/16"	No	3000/Case
10763	5/8"	2"	No	10 Pcs./Pack
10763B	5/8"	2"	No	4000/Case
10762	9/16"	1 1/2"	No	10 Pcs./Pack
10762B	9/16"	1 1/2"	No	4000/Case
10761	1/2"	1 7/16"	No	10 Pcs./Pack
10761B	1/2"	1 7/16"	No	5000/Case
10760	7/16"	1 1/4"	No	10 Pcs./Pack
10760B	7/16"	1 1/4"	No	5000/Case



10769B



10770



10763

Chrome Slotted Nut Cover - Push-On

Description

- Chrome Plastic 33mm Push-On Slotted Nut Cover

Item Number	Size	Height	Flange	Pack
10265	33 mm	2 3/4"	Yes	400/Case



Iron Cross Nut Cover - Push-On

Description

- Chrome Plastic Iron Cross Push-On Nut Cover for Hex Nuts and Bolts
- Available in Various Sizes

Item Number	Size	Height	Flange	Pack
10599B	33 mm	1 7/8"	No	500/Case
10598	1 1/8"	1 7/8"	No	10 Pcs./Pack
10598B	1 1/8"	1 7/8"	No	500/Case
10597	15/16"	1 1/2"	No	10 Pcs./Pack
10597B	15/16"	1 1/2"	No	500/Case
10596	3/4"	1 1/2"	No	10 Pcs./Pack
10596B	3/4"	1 1/2"	No	1000/Case
10595	3/4"	7/8"	No	10 Pcs./Pack
10595B	3/4"	7/8"	No	2000/Case
10594	11/16"	1 1/4"	No	10 Pcs./Pack
10594B	11/16"	1 1/4"	No	2000/Case
10593	5/8"	1 1/4"	No	10 Pcs./Pack
10593B	5/8"	1 1/4"	No	2000/Case
10592	9/16"	7/8"	No	10 Pcs./Pack
10592B	9/16"	7/8"	No	4000/Case
10591	1/2"	7/8"	No	10 Pcs./Pack
10591B	1/2"	7/8"	No	5000/Case
10590	7/16"	3/4"	No	10 Pcs./Pack
10590B	7/16"	3/4"	No	5000/Case

**Skull Nut Cover - Push-On**

Description

- Chrome Plastic Skull Push-On Skull Nut Cover for Hex Nuts and Bolts
- Available in Various Sizes

Item Number	Size	Height	Flange	Pack
10582	33 mm	1 7/8"	No	10 Pcs./Pack
10582B	33 mm	1 7/8"	No	500/Case
10581	1 1/8"	1 7/8"	No	10 Pcs./Pack
10581B	1 1/8"	1 7/8"	No	500/Case
10580	15/16"	1 1/2"	No	10 Pcs./Pack
10580B	15/16"	1 1/2"	No	1000/Case
10579	3/4"	1 1/2"	No	10 Pcs./Pack
10579B	3/4"	1 1/2"	No	1000/Case
10578	3/4"	7/8"	No	10 Pcs./Pack
10578B	3/4"	7/8"	No	2000/Case
10577	11/16"	1 1/4"	No	10 Pcs./Pack
10577B	11/16"	1 1/4"	No	2000/Case
10576	5/8"	1 1/4"	No	10 Pcs./Pack
10576B	5/8"	1 1/4"	No	1000/Case
10575	9/16"	7/8"	No	10 Pcs./Pack
10575B	9/16"	7/8"	No	4000/Case
10574	1/2"	7/8"	No	10 Pcs./Pack
10574B	1/2"	7/8"	No	2500/Case
10573	7/16"	3/4"	No	10 Pcs./Pack
10573B	7/16"	3/4"	No	5000/Case

33 MM THREAD-ON NUT COVER**Chrome Plastic Nut Cover - Thread-On**

Description

- Chrome Plastic 33 mm Thread-On Nut Covers, Available in Various Sizes and Styles
- 33mm Nut Cover Fits Lug Nuts on Hub Piloted Wheels
- All Nut Covers are Flanged to Cover Up the Flange on the 33 mm Nut

Item Number	Size	Height	Shape	Pack
10569	33 mm	4 3/4"	Super Spike	10 Pcs./Card
10569B	33 mm	4 3/4"	Super Spike	400/Case
10780	33 mm	4 1/2"	X Spike	10 Pcs./Pack
10780B	33 mm	4 1/2"	X Spike	400/Case
10781B	33 mm	4 3/8"	Razor	500/Case
10778	33 mm	4 1/4"	Stiletto	10 Pcs./Pack
10778B	33 mm	4 1/4"	Stiletto	500/Case
10007	33 mm	4 1/8"	Spike	10 Pcs./Pack
10007B	33 mm	4 1/8"	Spike	500/Case
10564	33 mm	3 7/8"	Bullet	10 Pcs./Pack
10564B	33 mm	3 7/8"	Bullet	500/Case
10563	33 mm	3 3/4"	Dome	10 Pcs./Pack
10563B	33 mm	3 3/4"	Dome	500/Case
10013	33 mm	3 1/2"	Cylinder	10 Pcs./Pack
10013B	33 mm	3 1/2"	Cylinder	500/Case
10034B	33 mm	4 1/4"	Tall Cylinder	400/Case
10014B	33 mm	2"	Citadel	500/Case
10064	33 mm	2 3/4"	Original	10 Pcs./Pack
10064B	33 mm	2 3/4"	Original	500/Case

10007
Spike10778
Stiletto10781B
Razor10034
Tall Cylinder10013
Cylinder10563
Dome10564
Bullet10014B
Citadel10064
Original



10569B
Super Spike

10780B
X Spike

Chrome Nut Cover Set

Description

- Chrome Plastic Huck Rivet/Nut Cover Set
- 48 Pieces Per Set: 1 3/16" x 1 9/16" Nut Covers (UP Item # 10774B) x 44 and 3/4" x 5/8" Nut Covers (UP Item # 10755B) x 4

Item Number	Description	Package	Pack
10773	Chrome Nut Cover Set	Carded	1 Set/Card



10755B



10774B

Recommended Accessories

Lug Nut Cover Puller - Steel Lug Nuts

Description

- Heavy Duty Lug Nut Cover Puller with Vinyl Coated Grips for Steel Lug Nuts

Item Number	Description	Pack
90008	Universal Lug Nut Cover Puller	Bulk = 1 Pc.
90007	1 1/2" Lug Nut Cover Puller	Bulk = 1 Pc.

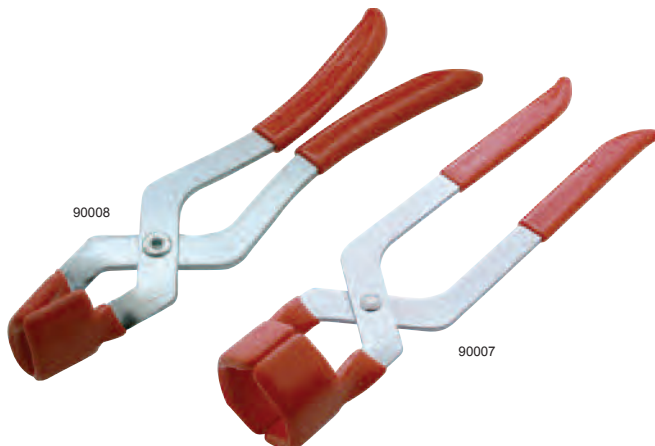

90008

90007

Lug Nut Cover Socket - Plastic Lug Nuts

Description

- 11" Plastic Lug Nut Cover Socket for Plastic Lug Nuts
- Facilitates the Installation and Removal of Chrome Plastic Lug Nut Cover

Item Number	Description	Package	Pack
10259	Lug Nut Cover Puller	Bulk	1 Pc.



"HUCK" BOLT COVER

Chrome "Huck" Bolt Cover

Description

- Chrome "Huck" Bolt Cover for Freightliner and International Trucks
- Freightliner Huck Bolt Cover is Made Out of Chrome Steel
- International Huck Bolt Cover is Made Out of Chrome Plastic, Available in 3 Different Sizes

Freightliner "Huck" Bolt Cover

Item Number	Size	Height	Flange	Pack
10085	1"	1 5/8"	No	2000/Case

International "Huck" Bolt Cover

Item Number	Size	Height	Flange	Pack
10775B	13/16"	1 1/4"	Yes	2000/Case
10776B	1"	1 7/8"	Yes	1000/Case
10777B	1 3/16"	2 1/8"	Yes	500/Case

Freightliner

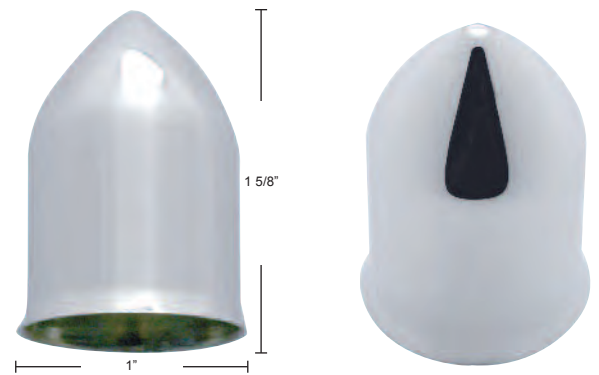

International

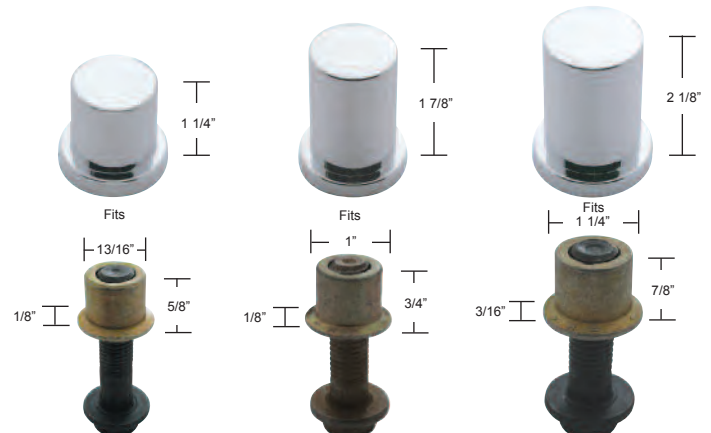

Full Size Pick-Up Nut Cover - Push-On

Description

- Chrome Plastic Full Size Pick-Up Nut Cover, Push-On
- Fits Various Ford, Chevy, and Dodge Full Size Pick-Up Trucks

Item Number	Size	Height	Flange	Pack
10749B	1"	2 3/16"	No	500/Case

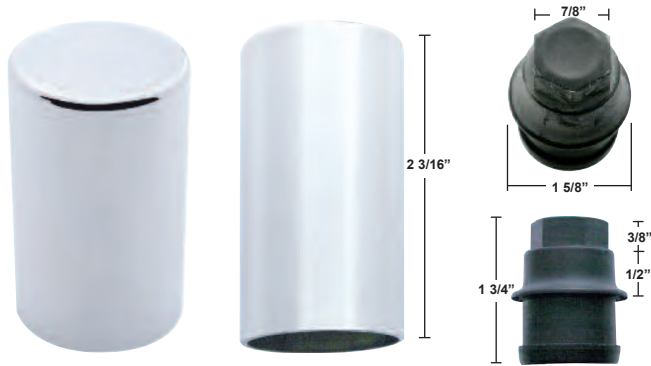

Chrome Snap-On Covers

Description

- Chrome Plastic Snap-On Covers
- Available for Various Size Screws

Item Number	Description	Package	Pack
70086	Fits Size 6 and 8 Screw	Carded	10 Pcs./Card
70086-1	Fits Size 6 and 8 Screw	Bulk	1 Pc.
70088	Fits Size 10 and 12 Screw	Carded	10 Pcs./Card
70088-1	Fits Size 10 and 12 Screw	Bulk	1 Pc.
70251	Fits Size 14/14 Screw	Carded	10 Pcs./Card
70251-1	Fits Size 14/14 Screw	Bulk	1 Pc.



Chrome Skull Snap-On Covers

Description

- Chrome Plastic Skull Snap-On Covers
- Available for Various Size Screws

Item Number	Description	Package	Pack
70196	Fits Size 10 and 12 Screw	Carded	10 Pcs./Card
70196B	Fits Size 10 and 12 Screw	Bulk	1 Pc.
70197	Fits Size 14/14 Screw	Carded	10 Pcs./Card
70197B	Fits Size 14/14 Screw	Bulk	1 Pc.



Chrome Push-On Torque Screw Cover

Description

- Chrome Plastic Push-On Torque Screw Head Cover
- Fits # 20 or # 25 Torque Screw with Large or Small Screw Heads

Item Number	Fits	Head	Package	Pack
70193	# 20 Torque	Large	Carded	10 Pcs./Card
70193-1	# 20 Torque	Large	Bulk	1 Pc.
70191	# 20 Torque	Small	Carded	10 Pcs./Card
70191-1	# 20 Torque	Small	Bulk	1 Pc.
70192	# 25 Torque	Small	Carded	10 Pcs./Card
70192-1	# 25 Torque	Small	Bulk	1 Pc.



Chrome Spike Snap-On Covers

Description

- Chrome Plastic Spike Snap-On Covers
- Only Fits Size 10/12 Screw

Item Number	Description	Package	Pack
70084	Fits Size 10/12 Screw	Carded	4 Pcs./Card



Chrome Push-On Phillips Screw Cover

Description

- Chrome Plastic Push-On Phillips Screw Head Cover
- Covers Up Ugly Phillips Screw Heads

Item Number	Description	Package	Pack
70090	Phillips Screw Cover	Carded	10 Pcs./Card





FRONT HUB CAP

Universal Front Hub Cap

Description

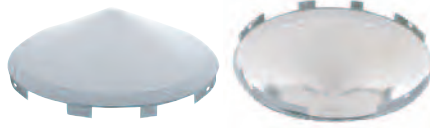
- Chrome or Stainless Steel Universal Notched Front Hub Cap
- Fits 4, 5, or 6 Notched Hubs, May not Fit Some 4 Even Notched Hub

Universal Front Hub Cap - Fits 8 23/32" Hub Bore								
Style	Item Number	Lip	Style	Material	Package	Pack	Case Qty.	
	10111	7/16"	Dome	Chrome	Bulk	1 Pc.	40/Case	
	20111	7/16"	Dome	Stainless	Bulk	1 Pc.	40/Case	
	20108	1"	Dome	Stainless	Bulk	1 Pc.	40/Case	
	10099	7/16"	Pointed	Chrome	Bulk	1 Pc.	40/Case	
	10154	7/16"	Pointed	Gold	Bulk	1 Pc.	40/Case	
	10100	1"	Pointed	Chrome	Bulk	1 Pc.	40/Case	
	20109	1"	Pointed	Stainless	Bulk	1 Pc.	40/Case	
	20159	7/16"	Classic	Stainless	Bulk	1 Pc.	40/Case	
	10158	1"	Classic	Chrome	Bulk	1 Pc.	40/Case	
	20158	1"	Classic	Stainless	Bulk	1 Pc.	40/Case	

Universal Front Hub Cap

Description

- Chrome or Stainless Steel Universal Notched Front Hub Cap
- Fits all Wheels

Item Number	Lip	Style	Material	Pack
10141	9/16"	Dome	Chrome	1 Pc.
20098	9/16"	Dome	Stainless	1 Pc.
10107	9/16"	Pointed	Chrome	1 Pc.



Universal Front Hub Cap - Spinner Hole

Description

- Universal Notched Front Hub Cap with Spinner Hole
- Fits 4, 5, or 6 Notched Hubs, May not Fit Some 4 Even Notched Hub
- Hub Cap Only, Spinner Available Separately

Item Number	Lip	Material	Pack	Case Qty.
10161-1	7/16"	Chrome	Bulk = 1 Pc.	40/Case

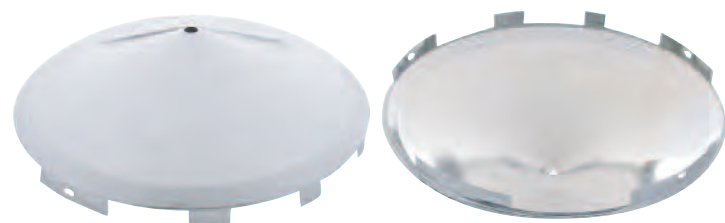

Universal 7/16" Lip Front Hub Cap - Spinner

Description

- Chrome Universal Notched 7/16" Lip Front Hub Cap with Spinner
- Fits 4, 5, or 6 Notched Hubs, May not Fit Some 4 Even Notched Hub
- Available with 6 Different Style Spinners
- 7/16" Lip Designed for Steel Wheels

Item Number	Spinner Style	Lip	Pack
10177	Gun Barrel	7/16"	1 Pc.
10178	Iron Cross	7/16"	1 Pc.
10179	2 Bar	7/16"	1 Pc.
10160	3 Bar - Straight	7/16"	1 Pc.
10161	3 Bar - Left Swing	7/16"	1 Pc.
10162	3 Bar - Right Swing	7/16"	1 Pc.



Front Hub Cap

Description

- Chrome or Stainless Steel Front Hub Cap, Available with No Notch, 4 Even Notched, 5 Even Notched, 6 Even Notched, or 6 Uneven Notched Style

No Notched Front Hub Cap - Fits 8 23/32" Hub Bore							
Style	Item Number	Lip	Style	Material	Package	Pack	Case Qty.
	10101	1/2"	Dome	Chrome	Bulk	1 Pc.	40/Case
	20101	1/2"	Dome	Stainless	Bulk	1 Pc.	40/Case
	10105	1/2"	Pointed	Chrome	Bulk	1 Pc.	40/Case
	20105	1/2"	Pointed	Stainless	Bulk	1 Pc.	40/Case
4 Even Notched Front Hub Cap - Fits 8 23/32" Hub Bore							
Style	Item Number	Lip	Style	Material	Package	Pack	Case Qty.
	10106	7/16"	Dome	Chrome	Bulk	1 Pc.	40/Case
	10106C *	7/16"	Dome	Chrome	Bulk	1 Pc.	40/Case
	20106	7/16"	Dome	Stainless	Bulk	1 Pc.	40/Case
	10118	1"	Dome	Chrome	Bulk	1 Pc.	40/Case
	10118C *	1"	Dome	Chrome	Bulk	1 Pc.	40/Case
	20118	1"	Dome	Stainless	Bulk	1 Pc.	40/Case
	10146	7/16"	Pointed	Chrome	Bulk	1 Pc.	40/Case
	10146C *	7/16"	Pointed	Chrome	Bulk	1 Pc.	40/Case
	20146	7/16"	Pointed	Stainless	Bulk	1 Pc.	40/Case
	10149	1"	Pointed	Chrome	Bulk	1 Pc.	40/Case
	10149C *	1"	Pointed	Chrome	Bulk	1 Pc.	40/Case
	20149	1"	Pointed	Stainless	Bulk	1 Pc.	40/Case
5 Even Notched Front Hub Cap - Fits 8 23/32" Hub Bore							
Style	Item Number	Lip	Style	Material	Package	Pack	Case Qty.
	10094	7/16"	Dome	Chrome	Bulk	1 Pc.	40/Case
	10094C *	7/16"	Dome	Chrome	Bulk	1 Pc.	40/Case
	20094	7/16"	Dome	Stainless	Bulk	1 Pc.	40/Case
	10119	1"	Dome	Chrome	Bulk	1 Pc.	40/Case
	10119C *	1"	Dome	Chrome	Bulk	1 Pc.	40/Case
	20119	1"	Dome	Stainless	Bulk	1 Pc.	40/Case
	10147	7/16"	Pointed	Chrome	Bulk	1 Pc.	40/Case
	10147C *	7/16"	Pointed	Chrome	Bulk	1 Pc.	40/Case
	20147	7/16"	Pointed	Stainless	Bulk	1 Pc.	40/Case
	10150	1"	Pointed	Chrome	Bulk	1 Pc.	40/Case
	10150C *	1"	Pointed	Chrome	Bulk	1 Pc.	40/Case
	20150	1"	Pointed	Stainless	Bulk	1 Pc.	40/Case
6 Even Notched Front Hub Cap - Fits 8 23/32" Hub Bore							
Style	Item Number	Lip	Style	Material	Package	Pack	Case Qty.
	10189	7/16"	Dome	Chrome	Bulk	1 Pc.	40/Case
6 Uneven Notched Front Hub Cap - Fits 8 23/32" Hub Bore							
Style	Item Number	Lip	Style	Material	Package	Pack	Case Qty.
	10166	7/16"	Dome	Chrome	Bulk	1 Pc.	40/Case
	20120	7/16"	Dome	Stainless	Bulk	1 Pc.	40/Case
	10167	1"	Dome	Chrome	Bulk	1 Pc.	40/Case
	20121	1"	Dome	Stainless	Bulk	1 Pc.	40/Case
	10168	7/16"	Pointed	Chrome	Bulk	1 Pc.	40/Case
	20122	7/16"	Pointed	Stainless	Bulk	1 Pc.	40/Case
	10169	1"	Pointed	Chrome	Bulk	1 Pc.	40/Case
	10169C *	1"	Pointed	Chrome	Bulk	1 Pc.	40/Case
20123	1"	Pointed	Stainless	Bulk	1 Pc.	40/Case	

Notches - United Pacific carries 5 of the most common type of front hub caps. Front hub caps can be divided into groups based on the number of notches around the base. The notches on the front hub cap fit onto "locators" on the front wheel hub.



No Notch



4 Even Notches



5 Even Notched



6 Even Notched

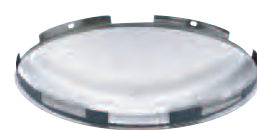

6 Uneven Notches

Chrome Front Hub Cap - 3/4" Side Wall

Description

- Chrome Steel Notched Front Hub Cap with 3/4" Tall Side Wall and 5/8" Lip
- Fits 8 23/32" Hub Bore
- Available with 4 Even, 5 Even, or 6 Even Notches

3/4"
Tall
Side
Wall



Item Number	Notches	Lip	Style	Pack	Case Qty.
10103	4 Even	5/8"	Dome	Bulk = 1 Pc.	40/Case
10104	5 Even	5/8"	Dome	Bulk = 1 Pc.	40/Case
10110	6 Even	5/8"	Dome	Bulk = 1 Pc.	40/Case



10103 - 4 Even



10104 - 5 Even



10110 - 6 Even

Front Hub Cap - Spinner Hole

Description

- Front Hub Cap with Hole for Spinner
- Hub Cap Only, Available with 4 Even, 5 Even, or 6 Uneven Notches

4 Even Notched Front Hub Cap - Spinner Hole

Item Number	Lip	Material	Pack	Case Qty.
10180	7/16"	Chrome	Bulk = 1 Pc.	40/Case
20124	7/16"	Stainless	Bulk = 1 Pc.	40/Case
10181	1"	Chrome	Bulk = 1 Pc.	40/Case
20125	1"	Stainless	Bulk = 1 Pc.	40/Case

5 Even Notched Front Hub Cap - Spinner Hole

Item Number	Lip	Material	Pack	Case Qty.
10182	7/16"	Chrome	Bulk = 1 Pc.	40/Case
20126	7/16"	Stainless	Bulk = 1 Pc.	40/Case
10183	1"	Chrome	Bulk = 1 Pc.	40/Case
20127	1"	Stainless	Bulk = 1 Pc.	40/Case

6 Uneven Notched Front Hub Cap - Spinner Hole

Item Number	Lip	Material	Pack	Case Qty.
10184	7/16"	Chrome	Bulk = 1 Pc.	40/Case
20130	7/16"	Stainless	Bulk = 1 Pc.	40/Case
10185	1"	Chrome	Bulk = 1 Pc.	40/Case
20131	1"	Stainless	Bulk = 1 Pc.	40/Case



Front Hub Cap - Iron Cross Spinner

Description

- Front Hub Cap with Iron Cross Spinner
- Available with 4 Even, 5 Even, or 6 Uneven Notches
- Iron Cross Spinner Available Separately: UP Item # 10725B

4 Even Notched Front Hub Cap - Iron Cross Spinner

Item Number	Lip	Material	Spinner	Pack
10155	7/16"	Chrome	10725B	Bulk = 1 Pc.
20155	7/16"	Stainless	10725B	Bulk = 1 Pc.
10156	1"	Chrome	10725B	Bulk = 1 Pc.
20156	1"	Stainless	10725B	Bulk = 1 Pc.

5 Even Notched Front Hub Cap - Iron Cross Spinner

Item Number	Lip	Material	Spinner	Pack
10173	7/16"	Chrome	10725B	Bulk = 1 Pc.
20173	7/16"	Stainless	10725B	Bulk = 1 Pc.
10174	1"	Chrome	10725B	Bulk = 1 Pc.
20174	1"	Stainless	10725B	Bulk = 1 Pc.

6 Uneven Notched Front Hub Cap - Iron Cross Spinner

Item Number	Lip	Material	Spinner	Pack
10175	7/16"	Chrome	10725B	Bulk = 1 Pc.
20175	7/16"	Stainless	10725B	Bulk = 1 Pc.
10176	1"	Chrome	10725B	Bulk = 1 Pc.
20176	1"	Stainless	10725B	Bulk = 1 Pc.

Front Hub Cap - Gun Barrel Spinner

Description

- Front Hub Cap with Gun Barrel Spinner
- Available with 4 Even, 5 Even, or 6 Uneven Notches
- Gun Barrel Spinner Available Separately: UP Item # 10710B

4 Even Notched Front Hub Cap - Gun Barrel Spinner

Item Number	Lip	Material	Spinner	Pack
10191	7/16"	Chrome	10710B	Bulk = 1 Pc.
20191	7/16"	Stainless	10710B	Bulk = 1 Pc.
10192	1"	Chrome	10710B	Bulk = 1 Pc.
20192	1"	Stainless	10710B	Bulk = 1 Pc.

5 Even Notched Front Hub Cap - Gun Barrel Spinner

Item Number	Lip	Material	Spinner	Pack
10193	7/16"	Chrome	10710B	Bulk = 1 Pc.
20193	7/16"	Stainless	10710B	Bulk = 1 Pc.
10194	1"	Chrome	10710B	Bulk = 1 Pc.
20194	1"	Stainless	10710B	Bulk = 1 Pc.

6 Uneven Notched Front Hub Cap - Gun Barrel Spinner

Item Number	Lip	Material	Spinner	Pack
10195	7/16"	Chrome	10710B	Bulk = 1 Pc.
20195	7/16"	Stainless	10710B	Bulk = 1 Pc.
10196	1"	Chrome	10710B	Bulk = 1 Pc.
20196	1"	Stainless	10710B	Bulk = 1 Pc.



Gun Barrel

Iron Cross

Front Hub Cap - 2 Bar SpinnerDescription

- Front Hub Cap with 2 Bar Spinner
- Available with 4 Even, 5 Even, or 6 Uneven Notches
- 2 Bar Spinner Available Separately: UP Item # 10724B

4 Even Notched Front Hub Cap - 2 Bar Spinner

Item Number	Lip	Material	Spinner	Pack
11100	7/16"	Chrome	10724B	Bulk = 1 Pc.
21100	7/16"	Stainless	10724B	Bulk = 1 Pc.
11101	1"	Chrome	10724B	Bulk = 1 Pc.
21101	1"	Stainless	10724B	Bulk = 1 Pc.

5 Even Notched Front Hub Cap - 2 Bar Spinner

Item Number	Lip	Material	Spinner	Pack
11102	7/16"	Chrome	10724B	Bulk = 1 Pc.
21102	7/16"	Stainless	10724B	Bulk = 1 Pc.
11103	1"	Chrome	10724B	Bulk = 1 Pc.
21103	1"	Stainless	10724B	Bulk = 1 Pc.

6 Uneven Notched Front Hub Cap - 2 Bar Spinner

Item Number	Lip	Material	Spinner	Pack
11104	7/16"	Chrome	10724B	Bulk = 1 Pc.
21104	7/16"	Stainless	10724B	Bulk = 1 Pc.
11105	1"	Chrome	10724B	Bulk = 1 Pc.
21105	1"	Stainless	10724B	Bulk = 1 Pc.



2 Bar Swing



3 Bar Left Swing



3 Bar Straight



3 Bar Right Swing

Front Hub Cap - Left Swing 3 Bar SpinnerDescription

- Front Hub Cap with Left Swing 3 Bar Spinner
- Available with 4 Even, 5 Even, or 6 Uneven Notches
- Left Swing Spinner Available Separately: UP Item # 10720

4 Even Notched Front Hub Cap - Left Swing Spinner

Item Number	Lip	Material	Spinner	Pack
11116	7/16"	Chrome	10720	Bulk = 1 Pc.
21116	7/16"	Stainless	10720	Bulk = 1 Pc.
11117	1"	Chrome	10720	Bulk = 1 Pc.
21117	1"	Stainless	10720	Bulk = 1 Pc.

5 Even Notched Front Hub Cap - Left Swing Spinner

Item Number	Lip	Material	Spinner	Pack
11118	7/16"	Chrome	10720	Bulk = 1 Pc.
21118	7/16"	Stainless	10720	Bulk = 1 Pc.
11119	1"	Chrome	10720	Bulk = 1 Pc.
21119	1"	Stainless	10720	Bulk = 1 Pc.

6 Uneven Notched Front Hub Cap - Left Swing Spinner

Item Number	Lip	Material	Spinner	Pack
11120	7/16"	Chrome	10720	Bulk = 1 Pc.
21120	7/16"	Stainless	10720	Bulk = 1 Pc.
11121	1"	Chrome	10720	Bulk = 1 Pc.
21121	1"	Stainless	10720	Bulk = 1 Pc.

Front Hub Cap - 3 Bar Straight SpinnerDescription

- Front Hub Cap with 3 Bar Straight Spinner
- Available with 4 Even, 5 Even, or 6 Uneven Notches
- Straight Spinner Available Separately: UP Item # 10723

4 Even Notched Front Hub Cap - Straight Spinner

Item Number	Lip	Material	Spinner	Pack
11110	7/16"	Chrome	10723	Bulk = 1 Pc.
21110	7/16"	Stainless	10723	Bulk = 1 Pc.
11111	1"	Chrome	10723	Bulk = 1 Pc.
21111	1"	Stainless	10723	Bulk = 1 Pc.

5 Even Notched Front Hub Cap - Straight Spinner

Item Number	Lip	Material	Spinner	Pack
11112	7/16"	Chrome	10723	Bulk = 1 Pc.
21112	7/16"	Stainless	10723	Bulk = 1 Pc.
11113	1"	Chrome	10723	Bulk = 1 Pc.
21113	1"	Stainless	10723	Bulk = 1 Pc.

6 Uneven Notched Front Hub Cap - Straight Spinner

Item Number	Lip	Material	Spinner	Pack
11114	7/16"	Chrome	10723	Bulk = 1 Pc.
21114	7/16"	Stainless	10723	Bulk = 1 Pc.
11115	1"	Chrome	10723	Bulk = 1 Pc.
21115	1"	Stainless	10723	Bulk = 1 Pc.

Front Hub Cap - Right Swing 3 Bar SpinnerDescription

- Front Hub Cap with Right Swing 3 Bar Spinner
- Available with 4 Even, 5 Even, or 6 Uneven Notches
- Right Swing Spinner Available Separately: UP Item # 10721

4 Even Notched Front Hub Cap - Right Swing Spinner

Item Number	Lip	Material	Spinner	Pack
11122	7/16"	Chrome	10721	Bulk = 1 Pc.
21122	7/16"	Stainless	10721	Bulk = 1 Pc.
11123	1"	Chrome	10721	Bulk = 1 Pc.
21123	1"	Stainless	10721	Bulk = 1 Pc.

5 Even Notched Front Hub Cap - Right Swing Spinner

Item Number	Lip	Material	Spinner	Pack
11124	7/16"	Chrome	10721	Bulk = 1 Pc.
21124	7/16"	Stainless	10721	Bulk = 1 Pc.
11125	1"	Chrome	10721	Bulk = 1 Pc.
21125	1"	Stainless	10721	Bulk = 1 Pc.

6 Uneven Notched Front Hub Cap - Right Swing Spinner

Item Number	Lip	Material	Spinner	Pack
11126	7/16"	Chrome	10721	Bulk = 1 Pc.
21126	7/16"	Stainless	10721	Bulk = 1 Pc.
11127	1"	Chrome	10721	Bulk = 1 Pc.
21127	1"	Stainless	10721	Bulk = 1 Pc.

Front hub caps install on the wheel hub through a series of metal clips. Attached to the notches on the front hub cap, the small metal clips create a "friction" fit between the hub cap and the hub. Most front hub caps require 4 clips for proper installation.

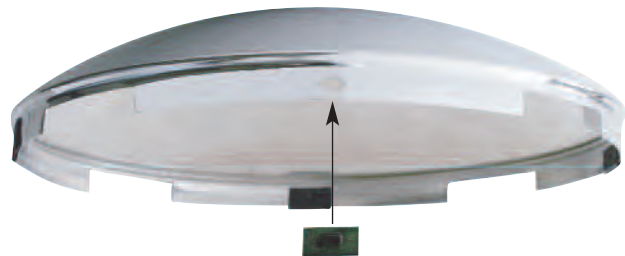

Front Hub Cap Clips

Description

- Steel Front Hub Cap Clips
- Available in Sets of 4 Pieces Only

Item Number	Description	Package	Pack
10102	Front Hub Cap Clips	Set	4 Pcs./Set



Hub Cap Mounting Tool

Description

- Hub Cap Mounting Tool
- Install Hub Caps in Seconds, Place Hub Cap in the Mounting Tool, Align with the Hub, and Hit the Protruding End of the Mounting Tool

Item Number	Description	Package	Pack
90052	Hub Cap Mounting Tool	Bulk	1 Pc.



Replacement Spinner and Accessories

Chrome Spinner

Description

- Chrome Plastic Spinner for Hub Cap
- Available in 6 Different Styles

Item Number	Description	Package	Pack
10710B	Gun Barrel	Bulk	1 Pc.
10725B	Iron Cross	Bulk	1 Pc.
10724B	2 Bar	Bulk	1 Pc.
10723	3 Bar - Straight	Bulk	1 Pc.
10720	3 Bar - Left Swing	Bulk	1 Pc.
10721	3 Bar - Right Swing	Bulk	1 Pc.



10710B
Gun Barrel



10725B
Iron Cross



10724B
2 Bar



10723
3 Bar Straight



10720
3 Bar Left Swing



10721
3 Bar Right Swing

Spinner Mounting Screw

Description

- Mounting Screw Set for Hub Cap Spinner
- Set Includes 1 Bolt, 1 Flat Washer, and 1 Locking Washer

Item Number	Description	Package	Pack
10161-2	Spinner Mounting Screw	Bulk	1 Set

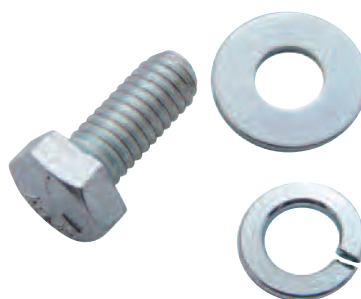

REAR HUB CAP



Dome



Pointed



Fullmoon



Hubdometer



Classic

Dome
1 1/2" Side Wall

Rear Hub Cap

Description

- Chrome or Stainless Steel Rear Hub Caps, Available in 5 Different Styles

Rear Hub Cap - Dome

Item Number	Style	I.D.	Application	Material	Pack	Case Qty.
10200	Dome	6 1/2"	Freightliner/International Tow Trucks	Chrome	Bulk = 1 Pc.	40/Case
10201	Dome	7 1/2"	7 1/4" Dia. Axle, 12 of 1/2" Studs	Chrome	Bulk = 1 Pc.	40/Case
10201C *	Dome	7 1/2"	7 1/4" Dia. Axle, 12 of 1/2" Studs (Economy)	Chrome	Bulk = 1 Pc.	40/Case
20201	Dome	7 1/2"	7 1/4" Dia. Axle, 12 of 1/2" Studs	Stainless	Bulk = 1 Pc.	40/Case
10202	Dome	8"	8 1/2" Dia. Axle, 8 of 5/8" Studs	Chrome	Bulk = 1 Pc.	40/Case
10202C *	Dome	8"	8 1/2" Dia. Axle, 8 of 5/8" Studs (Economy)	Chrome	Bulk = 1 Pc.	40/Case
20202	Dome	8"	8 1/2" Dia. Axle, 8 of 5/8" Studs	Stainless	Bulk = 1 Pc.	40/Case
10203	Dome	8 1/4"	8 1/2" Dia. Axle, 8 of 3/4" Studs	Chrome	Bulk = 1 Pc.	40/Case
10203C *	Dome	8 1/4"	8 1/2" Dia. Axle, 8 of 3/4" Studs (Economy)	Chrome	Bulk = 1 Pc.	40/Case
20203	Dome	8 1/4"	8 1/2" Dia. Axle, 8 of 3/4" Studs	Stainless	Bulk = 1 Pc.	40/Case
10240	Dome	8 1/2"	MACK 44,000 lb. Rear End	Chrome	Bulk = 1 Pc.	40/Case

Rear Hub Cap - Pointed

Item Number	Style	I.D.	Application	Material	Pack	Case Qty.
10227	Pointed	7 1/2"	7 1/4" Dia. Axle, 12 of 1/2" Studs	Chrome	Bulk = 1 Pc.	40/Case
20188	Pointed	7 1/2"	7 1/4" Dia. Axle, 12 of 1/2" Studs	Stainless	Bulk = 1 Pc.	40/Case
10228	Pointed	8"	8 1/2" Dia. Axle, 8 of 5/8" Studs	Chrome	Bulk = 1 Pc.	40/Case
20189	Pointed	8"	8 1/2" Dia. Axle, 8 of 5/8" Studs	Stainless	Bulk = 1 Pc.	40/Case
10229	Pointed	8 1/4"	8 1/2" Dia. Axle, 8 of 3/4" Studs	Chrome	Bulk = 1 Pc.	40/Case
20190	Pointed	8 1/4"	8 1/2" Dia. Axle, 8 of 3/4" Studs	Stainless	Bulk = 1 Pc.	40/Case

Rear Hub Cap - Fullmoon

Item Number	Style	I.D.	Application	Material	Pack	Case Qty.
10232	Fullmoon	8"	8 1/2" Dia. Axle, 8 of 5/8" Studs	Chrome	Bulk = 1 Pc.	28/Case
10233	Fullmoon	8 1/4"	8 1/2" Dia. Axle, 8 of 3/4" Studs	Chrome	Bulk = 1 Pc.	28/Case

Rear Hub Cap - Classic

Item Number	Style	I.D.	Application	Material	Pack	Case Qty.
10242	Classic	8"	8 1/2" Dia. Axle, 8 of 5/8" Studs	Chrome	Bulk = 1 Pc.	40/Case
20182	Classic	8"	8 1/2" Dia. Axle, 8 of 5/8" Studs	Stainless	Bulk = 1 Pc.	40/Case

Rear Hub Cap - Hubdometer Cutout

Item Number	Style	I.D.	Application	Material	Pack	Case Qty.
10204	Hubdometer	7 1/2"	7 1/4" Dia. Axle, 12 of 1/2" Studs	Chrome	Bulk = 1 Pc.	40/Case
20204	Hubdometer	7 1/2"	7 1/4" Dia. Axle, 12 of 1/2" Studs	Stainless	Bulk = 1 Pc.	40/Case
10205	Hubdometer	8"	8 1/2" Dia. Axle, 8 of 5/8" Studs	Chrome	Bulk = 1 Pc.	40/Case
20205	Hubdometer	8"	8 1/2" Dia. Axle, 8 of 5/8" Studs	Stainless	Bulk = 1 Pc.	40/Case
10206	Hubdometer	8 1/4"	8 1/2" Dia. Axle, 8 of 3/4" Studs	Chrome	Bulk = 1 Pc.	40/Case
20206	Hubdometer	8 1/4"	8 1/2" Dia. Axle, 8 of 3/4" Studs	Stainless	Bulk = 1 Pc.	40/Case

Rear Hub Cap with Spinner

Description

- Rear Hub Cap with Spinner
- Hub Cap Available in Chrome or Stainless Steel
- Spinner Available in 6 Different Styles



Gun Barrel



Iron Cross



2 Bar



3 Bar Straight



3 Bar Left Swing



3 Bar Right Swing

Rear Hub Cap with Spinner - Gun Barrel

Item Number	Spinner	I.D.	Application	Material	Pack
10197	Gun Barrel	7 1/2"	7 1/4" Dia. Axle, 12 of 1/2" Studs	Chrome	Bulk = 1 Pc.
20197	Gun Barrel	7 1/2"	7 1/4" Dia. Axle, 12 of 1/2" Studs	Stainless	Bulk = 1 Pc.
10198	Gun Barrel	8"	8 1/2" Dia. Axle, 8 of 5/8" Studs	Chrome	Bulk = 1 Pc.
20198	Gun Barrel	8"	8 1/2" Dia. Axle, 8 of 5/8" Studs	Stainless	Bulk = 1 Pc.
10199	Gun Barrel	8 1/4"	8 1/2" Dia. Axle, 8 of 3/4" Studs	Chrome	Bulk = 1 Pc.
20199	Gun Barrel	8 1/4"	8 1/2" Dia. Axle, 8 of 3/4" Studs	Stainless	Bulk = 1 Pc.

Rear Hub Cap with Spinner - Iron Cross

Item Number	Spinner	I.D.	Application	Material	Pack
10170	Iron Cross	7 1/2"	7 1/4" Dia. Axle, 12 of 1/2" Studs	Chrome	Bulk = 1 Pc.
20170	Iron Cross	7 1/2"	7 1/4" Dia. Axle, 12 of 1/2" Studs	Stainless	Bulk = 1 Pc.
10171	Iron Cross	8"	8 1/2" Dia. Axle, 8 of 5/8" Studs	Chrome	Bulk = 1 Pc.
20171	Iron Cross	8"	8 1/2" Dia. Axle, 8 of 5/8" Studs	Stainless	Bulk = 1 Pc.
10172	Iron Cross	8 1/4"	8 1/2" Dia. Axle, 8 of 3/4" Studs	Chrome	Bulk = 1 Pc.
20172	Iron Cross	8 1/4"	8 1/2" Dia. Axle, 8 of 3/4" Studs	Stainless	Bulk = 1 Pc.

Rear Hub Cap with Spinner - 2 Bar

Item Number	Spinner	I.D.	Application	Material	Pack
11106	2 Bar	7 1/2"	7 1/4" Dia. Axle, 12 of 1/2" Studs	Chrome	Bulk = 1 Pc.
21106	2 Bar	7 1/2"	7 1/4" Dia. Axle, 12 of 1/2" Studs	Stainless	Bulk = 1 Pc.
11107	2 Bar	8"	8 1/2" Dia. Axle, 8 of 5/8" Studs	Chrome	Bulk = 1 Pc.
21107	2 Bar	8"	8 1/2" Dia. Axle, 8 of 5/8" Studs	Stainless	Bulk = 1 Pc.
11108	2 Bar	8 1/4"	8 1/2" Dia. Axle, 8 of 3/4" Studs	Chrome	Bulk = 1 Pc.
21108	2 Bar	8 1/4"	8 1/2" Dia. Axle, 8 of 3/4" Studs	Stainless	Bulk = 1 Pc.

Rear Hub Cap with Spinner - 3 Bar Straight

Item Number	Spinner	I.D.	Application	Material	Pack
11128	Straight	7 1/2"	7 1/4" Dia. Axle, 12 of 1/2" Studs	Chrome	Bulk = 1 Pc.
21128	Straight	7 1/2"	7 1/4" Dia. Axle, 12 of 1/2" Studs	Stainless	Bulk = 1 Pc.
11129	Straight	8"	8 1/2" Dia. Axle, 8 of 5/8" Studs	Chrome	Bulk = 1 Pc.
21129	Straight	8"	8 1/2" Dia. Axle, 8 of 5/8" Studs	Stainless	Bulk = 1 Pc.
11130	Straight	8 1/4"	8 1/2" Dia. Axle, 8 of 3/4" Studs	Chrome	Bulk = 1 Pc.
21130	Straight	8 1/4"	8 1/2" Dia. Axle, 8 of 3/4" Studs	Stainless	Bulk = 1 Pc.

Rear Hub Cap with Spinner - 3 Bar Left Swing

Item Number	Spinner	I.D.	Application	Material	Pack
11131	Left Swing	7 1/2"	7 1/4" Dia. Axle, 12 of 1/2" Studs	Chrome	Bulk = 1 Pc.
21131	Left Swing	7 1/2"	7 1/4" Dia. Axle, 12 of 1/2" Studs	Stainless	Bulk = 1 Pc.
11132	Left Swing	8"	8 1/2" Dia. Axle, 8 of 5/8" Studs	Chrome	Bulk = 1 Pc.
21132	Left Swing	8"	8 1/2" Dia. Axle, 8 of 5/8" Studs	Stainless	Bulk = 1 Pc.
11133	Left Swing	8 1/4"	8 1/2" Dia. Axle, 8 of 3/4" Studs	Chrome	Bulk = 1 Pc.
21133	Left Swing	8 1/4"	8 1/2" Dia. Axle, 8 of 3/4" Studs	Stainless	Bulk = 1 Pc.

Rear Hub Cap with Spinner - 3 Bar Right Swing

Item Number	Spinner	I.D.	Application	Material	Pack
11134	Right Swing	7 1/2"	7 1/4" Dia. Axle, 12 of 1/2" Studs	Chrome	Bulk = 1 Pc.
21134	Right Swing	7 1/2"	7 1/4" Dia. Axle, 12 of 1/2" Studs	Stainless	Bulk = 1 Pc.
11135	Right Swing	8"	8 1/2" Dia. Axle, 8 of 5/8" Studs	Chrome	Bulk = 1 Pc.
21135	Right Swing	8"	8 1/2" Dia. Axle, 8 of 5/8" Studs	Stainless	Bulk = 1 Pc.
11136	Right Swing	8 1/4"	8 1/2" Dia. Axle, 8 of 3/4" Studs	Chrome	Bulk = 1 Pc.
21136	Right Swing	8 1/4"	8 1/2" Dia. Axle, 8 of 3/4" Studs	Stainless	Bulk = 1 Pc.

Spinner Available Separately, Please See Page 15 for More Information

Gun Barrel
10710BIron Cross
10725B2 Bar
10724B3 Bar Straight
107233 Bar Left
107203 Bar Right
10721

TRAILER HUB CAP

Trailer Hub Cap

Description

- 9 1/4" Trailer Hub Cap
- Available in Chrome or Stainless Steel
- Includes 3 Trailer Hub Cap Mounting Clips, Clips Available Separately: UP Item # 10209

Item Number	Size	Material	Package	Pack
10207	9 1/4"	Chrome	Bulk	1 Pc.
10207C	9 1/4"	Econ. Chrome	Bulk	1 Pc.
20207	9 1/4"	Stainless	Bulk	1 Pc.



Trailer Hub Cap Clip

Description

- Trailer Hub Cap Mounting Clip with 3/8" Dia. Hole
- Holds 9 1/4" Trailer Hub Caps in Place
- Available in Sets of 3 Pcs. Only

Item Number	Description	Package	Pack
10209	Hub Cap Clip	Set	3 Pcs./Set
10209P	Hub Cap Clip	Carded	3 Pcs./Card



Trailer Hub Cap Clip - STEMCO Axle

Description

- Designed for Use on STEMCO Axles to Hold Regular 8" Hub Cap in Place
- Eliminate the Need to Stock Special Size Trailer Caps & Clips
- Available in Sets of 3 Pcs. Only

Item Number	Description	Package	Pack
10219	Hub Cap Clip - STEMCO Axle	Set	3 Pcs./Set
10219P	Hub Cap Clip - STEMCO Axle	Carded	3 Pcs./Card



Trailer Hub Cap Bracket

Description

- Trailer Hub Cap Mounting Bracket, Allows the Use of Standard 8" Rear Hub Cap on the Trailer Axle
- Item # 10114 - Universal Mounting Bracket with Notch for Trailer Axle
- Item # 10113 - Mounting Bracket for Trailer Axle with Metal Oil Seal Caps
- Item # 10115 - Mounting Bracket for Trailer Axle with Plastic Oil Seal Caps
- Item # 10116 - Mounting Bracket for Trailer Oil Seal Cap, Mount Directly onto the Oil Seal Cap
- Item # 10234 - Mounting Bracket for 2005 and Newer Stemco Trailer Hub

Item Number	Description	Package	Pack
10114	Universal Notch Bracket	Bulk	1 Pc.
10113	Bracket for Metal Oil Seal Cap	Bulk	1 Pc.
10115	Bracket for Plastic Oil Seal Cap	Bulk	1 Pc.
10116	Bracket for Oil Seal Cap	Bulk	1 Pc.
10234	Stemco Hub Cap Bracket	Bulk	1 Pc.

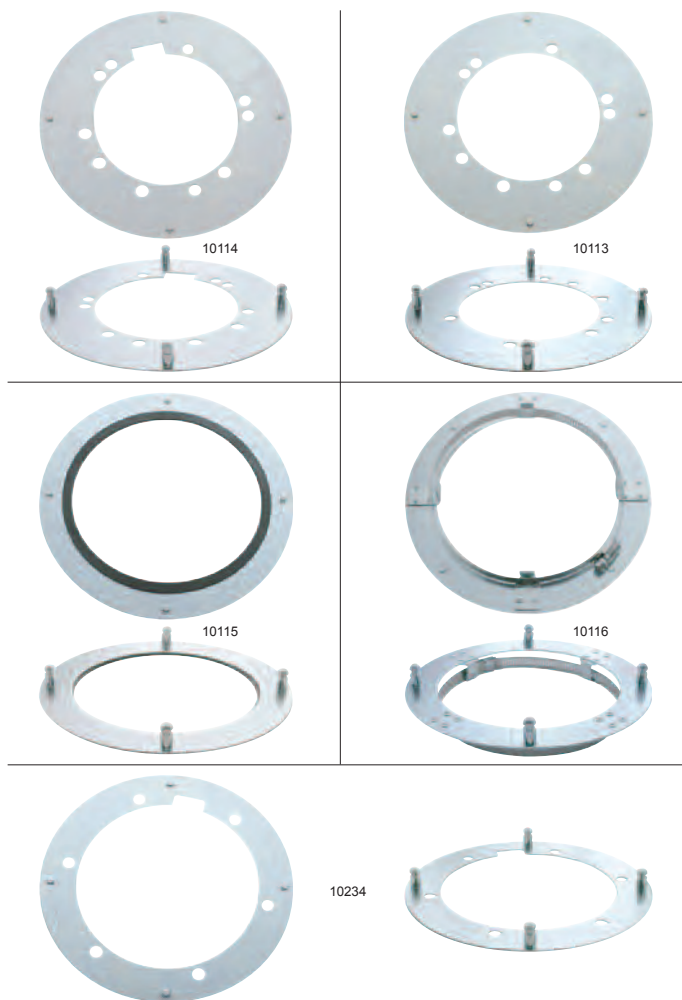

- The hub cap mounting bracket allows the use of standard 8" rear hub cap on various trailer axle.

- Install the trailer hub cap mounting bracket by using the existing bolt on the trailer hub face. Remove and reattach the hub bolts through the predrilled holes on the trailer hub cap mounting bracket. United Pacific trailer hub cap bracket is predrilled to accommodate a wide range of trailer axle hubs.

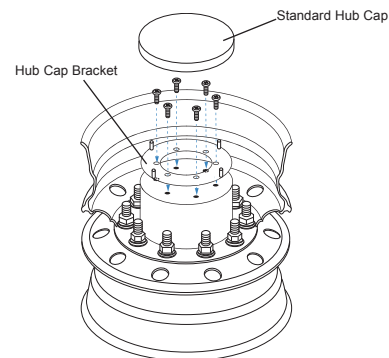

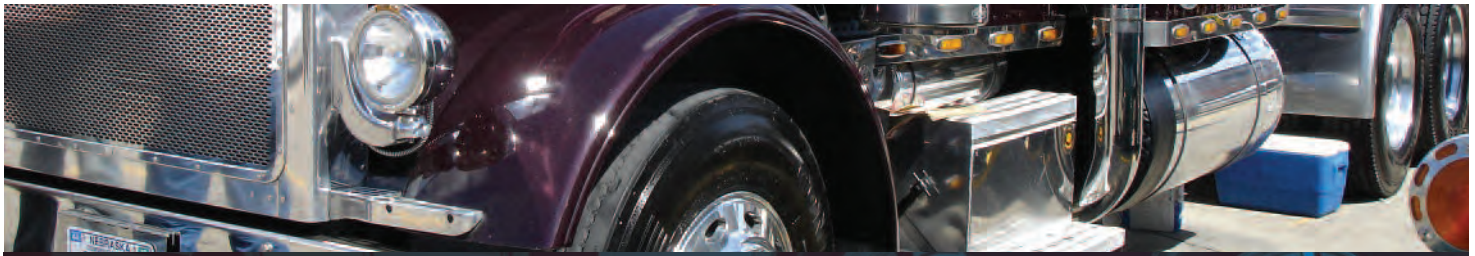

FRONT AND REAR AXLE COVER AND ACCESSORIES

Chrome Plastic Rear Axle Cover - Single Hub Design

Description

- Chrome Plastic Rear Axle Cover, Single Hub Design with Removable Cap
- Unique Single Hub Design Covers Up All the Lug Nut Covers, Extra Clean Appearance, Thread-On Chrome Lug Nut Covers
- Universal Fit, Fits Most 11 1/4" Bolt Circle/Center Applications
- Fits Most 20", 22 1/2", and 24 1/2" Wheel
- Includes 1 Cover, 1 Cap, and Ten 33mm Thread-On Nut Covers Per Kit

Item Number	Description	Nut Cover	Pack
10272	33 mm Single Hub Design	33 mm	1 Kit/Box



Chrome Plastic Front Axle Cover

Description

- Chrome Front ABS Axle Cover with Removable Cap
- Universal Fit, Fits Most 11 1/4" Bolt Circle/Center Applications
- Available with 33mm Thread-On or 1 1/2" Push-On Nut Covers
- Fits Most 20", 22 1/2", and 24 1/2" Wheel
- Includes 1 Cover, 1 Cap, and 10 Nut Covers Per Kit
- UP # 10262 Also Includes 2 Metal Washers

Item Number	Description	Nut Cover	Pack
10260	33 mm Thread-On	33 mm	1 Kit/Card
10257 *	33 mm Thread-On	33 mm	1 Kit/Card
10262	1 1/2" Push-On	1 1/2"	1 Kit/Card

Replacement Parts

- 10260-1** Dome Hub Cap Only, Front Axle, Fits Only 10260 and 10262
- 10258B** Pointed Hub Cap Only, Front Axle, Fits Only 10260 and 10262
- 10064B** 33mm Thread-On Nut Cover



Chrome Plastic Rear Axle Cover

Description

- Chrome Rear ABS Axle Cover with Removable Cap
- Universal Fit, Fits Most 11 1/4" and Bolt Circle/Center Applications
- Available with 33mm Thread-On or 1 1/2" Push-On Nut Covers
- Fits Most 20", 22 1/2", and 24 1/2" Wheel
- Includes 1 Cover, 1 Cap, and 10 Nut Covers Per Kit
- UP # 10256, 10266 Also Includes 2 Metal Washers

Item Number	Description	Nut Cover	Style
10264	33 mm Thread-On	33 mm	Dome
10263 *	33 mm Thread-On	33 mm	Dome
10261	33 mm Thread-On	33 mm	Pointed
10266	1 1/2" Push-On	1 1/2"	Dome
10256 *	1 1/2" Push-On	1 1/2"	Dome

Replacement Parts

- 10264-1** Dome Hub Cap Only, Rear Axle, Fits Only 10264 and 10266
- 10267B** Pointed Hub Cap Only, Rear Axle, Fits Only 10264 and 10266
- 10263-1** Economy Dome Rear Hub Cap
- 10064B** 33mm Thread-On Nut Cover

Recommended Accessories / Replacement Parts



Chrome Plastic Rear Hub Cap

Description

- Chrome Plastic Rear Hub Cap for United Pacific Rear Axle Cover Kit
- Available in Dome or Pointed Style, Also Available with Spinner Hole
- Item # 10264-1, 10267B, and 10267-1B Only Fit United Pacific Rear Axle Cover Kit (Item # 10264 and 10266)
- Item # 10263-1 Only Fits United Pacific Economy Rear Axle Cover (Item # 10263 and 10256)

Item Number	Description	Pack
10264-1	Dome Rear Hub Cap	Bulk = 1 Pc.
10267B	Pointed Rear Hub Cap	Bulk = 1 Pc.
10263-1	Economy Dome Rear Hub Cap	Bulk = 1 Pc.
10267-1B	Pointed Rear Hub Cap with Spinner Hole	Bulk = 1 Pc.

Chrome Plastic Rear Hub Cap - Spinner

Description

- Chrome Plastic Rear Hub Cap with Spinner for United Pacific Rear Axle Cover
- Available with 6 Different Spinners
- Only Fits United Pacific Rear Axle Cover Kit (Item # 10264 and 10266), Will Not Fit United Pacific Economy Rear Axle Cover (Item # 10263 and 10256)

Item Number	Spinner Style	Spinner	Pack
10273	Gun Barrel	10710B	Bulk = 1 Pc.
10268B	Iron Cross	10725B	Bulk = 1 Pc.
10274	2 Bar	10724B	Bulk = 1 Pc.
10271B	3 Bar - Straight	10723	Bulk = 1 Pc.
10269B	3 Bar - Left Swing	10720	Bulk = 1 Pc.
10270B	3 Bar - Right Swing	10721	Bulk = 1 Pc.



Chrome Plastic Front Hub Cap

Description

- Chrome Plastic Front Hub Cap for United Pacific Front Axle Cover Kit
- Available in Dome or Pointed Style, Also Available with Spinner Hole
- Only Fits United Pacific Front Axle Cover Kit (Item # 10260 and 10262), Will Not Fit United Pacific Economy Front Axle Cover (Item # 10257)

Item Number	Description	Pack
10260-1	Dome Front Hub Cap	Bulk = 1 Pc.
10258B	Pointed Front Hub Cap	Bulk = 1 Pc.
10258-1B	Pointed Front Hub Cap with Spinner Hole	Bulk = 1 Pc.

Chrome Plastic Front Hub Cap - Spinner

Description

- Chrome Plastic Front Hub Cap with Spinner for United Pacific Front Axle Cover
- Available with 6 Different Spinners
- Only Fits United Pacific Front Axle Cover Kit (Item # 10260 and 10262), Will Not Fit United Pacific Economy Front Axle Cover (Item # 10251)

Item Number	Spinner Style	Spinner	Pack
10279	Gun Barrel	10710B	Bulk = 1 Pc.
10296B	Iron Cross	10725B	Bulk = 1 Pc.
10280	2 Bar	10724B	Bulk = 1 Pc.
10299B	3 Bar - Straight	10723	Bulk = 1 Pc.
10297B	3 Bar - Left Swing	10720	Bulk = 1 Pc.
10298B	3 Bar - Right Swing	10721	Bulk = 1 Pc.



Available Spinner Styles



Gun Barrel
10710B



Iron Cross
10725B



2 Bar
10724B



Straight
10723



Left Swing
10720



Right Swing
10721

Chrome Plastic Nut Cover

Description

- Chrome Plastic Nut Cover for United Pacific Chrome Plastic Axle Covers
- Available in 33mm Thread-On or 1 1/2" Push-On

33 mm Chrome Plastic Nut Cover - Thread-On

Item Number	Size	Heights	Shape	Flange	Pack
10569B	33 mm	4 3/4"	Spike	Yes	400/Case
10780	33 mm	4 1/2"	X Spike	Yes	10 Pcs./Pack
10780B	33 mm	4 1/2"	X Spike	Yes	400/Case
10781B	33 mm	4 3/8"	Razor	Yes	500/Case
10778	33 mm	4 1/4"	Stiletto	Yes	10 Pcs./Pack
10778B	33 mm	4 1/4"	Stiletto	Yes	500/Case
10007	33 mm	4 1/8"	Spike	Yes	10 Pcs./Pack
10007B	33 mm	4 1/8"	Spike	Yes	500/Case
10564	33 mm	3 7/8"	Bullet	Yes	10 Pcs./Pack
10564B	33 mm	3 7/8"	Bullet	Yes	500/Case
10563	33 mm	3 3/4"	Dome	Yes	10 Pcs./Pack
10563B	33 mm	3 3/4"	Dome	Yes	500/Case
10013	33 mm	3 1/2"	Cylinder	Yes	10 Pcs./Pack
10013B	33 mm	3 1/2"	Cylinder	Yes	500/Case
10034B	33 mm	4 1/4"	Tall Cylinder	Yes	400/Case
10014B	33 mm	2"	Citadel	Yes	500/Case
10064	33 mm	2 3/4"	Original	Yes	10 Pcs./Pack
10064B	33 mm	2 3/4"	Original	Yes	500/Case

1 1/2" Chrome Plastic Nut Cover - Push-On

Item Number	Size	Height	Shape	Flange	Pack
10779	1 1/2"	4 1/4"	Stiletto	Yes	10 Pcs./Card
10779B	1 1/2"	4 1/4"	Stiletto	Yes	Bulk = 1 Pc.
10770	1 1/2"	4 1/4"	Spike	Yes	10 Pcs./Card
10770B	1 1/2"	4 1/4"	Spike	Yes	Bulk = 1 Pc.



Chrome Plastic Rear Axle Cover - No Hub Cap

Description

- Chrome Rear ABS Axle Cover without Hub Cap
- Universal Fit, Fits Most 11 1/4" Bolt Circle/Center Applications
- Available with 33mm Thread-On Nut Cover
- Fits Most 20", 22 1/2", and 24 1/2" Wheel
- 1 Axle Cover, and 10 Nut Covers Per Kit, No Hub Cap

Item Number	Description	Nut Covers	Pack
10264-2	33 mm Thread-On	33 mm	1 Kit/Box

10264-2 is designed for drivers wanting to replace their Rear Axle Cover with pointed or spinner hub caps. To customize the Rear Axle Cover, simply purchase 10264-2 and the desired cap to create an unique design. Spinner Hub caps are available with 6 different spinner designs.



Chrome Plastic Single Hub Axle Cover Cap

Description

- Replacement Hub Cap for Chrome Single Hub Rear Axle Cover
- Only fits United Pacific Single Hub Design Rear Axle Cover (UP # 10272)

Item Number	Description	Package	Pack
10272-1	Hub Cap Only	Bulk	1 Pc.

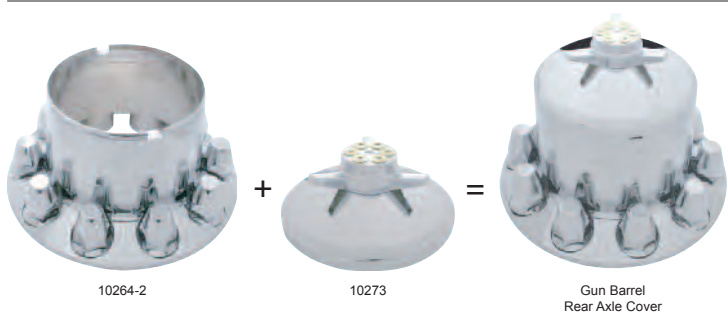



10131
Stud Piloted / Steel Wheel



10132
Stud Piloted (Tapered) / Aluminum Wheel



10133
Hub Piloted



10134
Hub Piloted

Chrome Front Axle Cover - 2 Piece Kit

Description

- Chrome Steel 2 Piece Front Axle and Hub Cover
- 2 1/8" Tall Cap, Fits Most 20", 22 1/2", and 24 1/2" Wheel
- Bolt Pattern: 11 1/4" Center to Center, Includes Hat and Beauty Ring

Item Number	Fits Wheel	Lug	Nut Size	Holes	Large Hole	Small Hole	Tapered	Wheel Type	Hub Type
10131	20", 22.5", 24.5"	10	1 1/2"	5 Big/5 Small	1 3/4" / 44 mm	1 9/16" / 40 mm	No	Steel	Stud Piloted
10132	20", 22.5", 24.5"	10	1 1/2"	5 Big/5 Small	1 3/4" / 44 mm	1 9/16" / 40 mm	Yes	Aluminum	Stud Piloted
10133	20", 22.5", 24.5"	10	33 mm	10	1 1/4" / 32 mm	1 1/4" / 32 mm	No	Steel/Aluminum	Hub Piloted
10134	20", 22.5", 24.5"	8	33 mm	8	1 1/4" / 32 mm	1 1/4" / 32 mm	No	Steel/Aluminum	Hub Piloted

Replacement Parts

- 10139** Chrome 2 1/8" Tall Axle Hat/Cover Only, without Beauty Ring
- 10214** Chrome Beauty Ring Only for Item # 10131, 10 Holes, for Steel Stud Piloted Wheel
- 10215** Chrome Beauty Ring Only for Item # 10132, 10 Holes, Tapered, for Aluminum Stud Piloted Wheel
- 10218** Chrome Beauty Ring Only for Item # 10133, 10 Holes, Uni-Mount, for Steel or Aluminum Hub Piloted Wheel
- 10220** Chrome Beauty Ring Only for Item # 10134, 8 Holes, Uni-Mount, for Steel or Aluminum Hub Piloted Wheel

Recommended Accessories / Replacement Parts

Chrome Front Axle/Hub Hat - Hat Only

Description

- Chrome 2 1/8" Tall Axle/Hub Hat Only
- Without Beauty Ring

Item Number	Description	Pack
10139	2 1/8" Tall Axle/Hub Hat Only	Bulk = 1 Pc.



2 1/8"

Chrome Beauty Ring - Beauty Ring Only

Description

- Chrome Beauty Ring Only for Front Axle Cover
- Without Hat, Fits Most 20", 22 1/2", and 24 1/2" Wheel
- Replacement Beauty Ring for United Pacific Front Axle Cover

Item Number	Description	Lug	Nut Size	Holes	Tapered	Wheel Type	Hub Type	Pack
10214	Beauty Ring for Item # 10131	10	1 1/2"	5 Big/5 Small	No	Steel	Stud Piloted	Bulk = 1 Pc.
10215	Beauty Ring for Item # 10132	10	1 1/2"	5 Big/5 Small	Yes	Aluminum	Stud Piloted	Bulk = 1 Pc.
10218	Beauty Ring for Item # 10133	10	33 mm	10	No	Steel/Aluminum	Hub Piloted	Bulk = 1 Pc.
10220	Beauty Ring for Item # 10134	8	33 mm	8	No	Steel/Aluminum	Hub Piloted	Bulk = 1 Pc.

13 1/2"

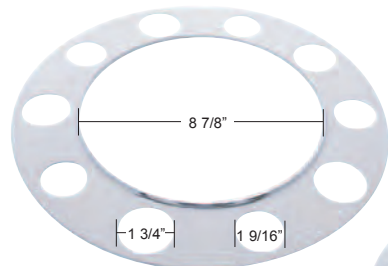

10214
Stud Piloted / Steel Wheel

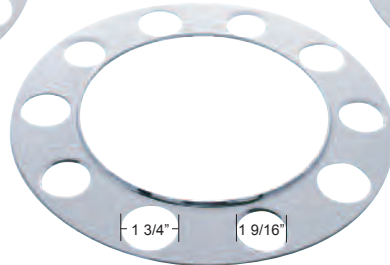

10215
Stud Piloted (Tapered) / Aluminum Wheel

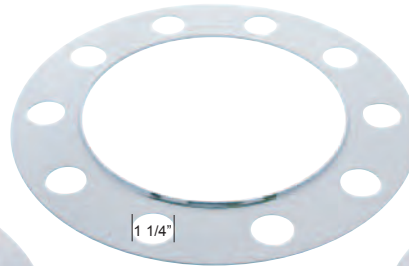

10218
Hub Piloted

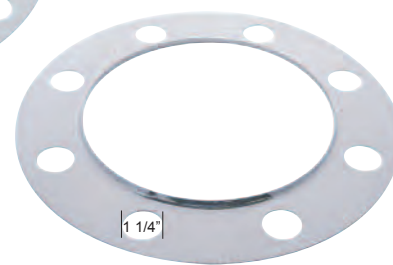

10220
Hub Piloted



Dome Cap



Pointed Cap



Hubdometer Cap

Chrome Front Axle Cover - 3 Piece Kit

Description

- Chrome Steel 3 Piece Front Axle and Hub Cover
- 2 1/2" Tall Cap, Fits Most 20", 22 1/2", and 24 1/2" Wheel
- Removable Hub Cap and Axle Hat, Bolt Pattern: 11 1/4" Center to Center

Dome Hub Cap

Item Number	Fits Wheel	Lug	Nut Size	Holes	Large Hole	Small Hole	Tapered	Wheel Type	Hub Type
10121	20", 22.5", 24.5"	10	1 1/2"	5 Big/5 Small	1 3/4" / 44 mm	1 9/16" / 40 mm	No	Steel	Stud Piloted
10122	20", 22.5", 24.5"	10	1 1/2"	5 Big/5 Small	1 3/4" / 44 mm	1 9/16" / 40 mm	Yes	Aluminum	Stud Piloted
10123	20", 22.5", 24.5"	10	33 mm	10	1 1/4" / 32 mm	1 1/4" / 32 mm	No	Steel/Aluminum	Hub Piloted
10130	20", 22.5", 24.5"	8	33 mm	8	1 1/4" / 32 mm	1 1/4" / 32 mm	No	Steel/Aluminum	Hub Piloted

Pointed Hub Cap

Item Number	Fits Wheel	Lug	Nut Size	Holes	Large Hole	Small Hole	Tapered	Wheel Type	Hub Type
10124	20", 22.5", 24.5"	10	1 1/2"	5 Big/5 Small	1 3/4" / 44 mm	1 9/16" / 40 mm	No	Steel	Stud Piloted
10125	20", 22.5", 24.5"	10	1 1/2"	5 Big/5 Small	1 3/4" / 44 mm	1 9/16" / 40 mm	Yes	Aluminum	Stud Piloted
10126	20", 22.5", 24.5"	10	33 mm	10	1 1/4" / 32 mm	1 1/4" / 32 mm	No	Steel/Aluminum	Hub Piloted
10137	20", 22.5", 24.5"	8	33 mm	8	1 1/4" / 32 mm	1 1/4" / 32 mm	No	Steel/Aluminum	Hub Piloted

Hubdometer Hub Cap

Item Number	Fits Wheel	Lug	Nut Size	Holes	Large Hole	Small Hole	Tapered	Wheel Type	Hub Type
10127	20", 22.5", 24.5"	10	1 1/2"	5 Big/5 Small	1 3/4" / 44 mm	1 9/16" / 40 mm	No	Steel	Stud Piloted
10129	20", 22.5", 24.5"	10	1 1/2"	5 Big/5 Small	1 3/4" / 44 mm	1 9/16" / 40 mm	Yes	Aluminum	Stud Piloted
10136	20", 22.5", 24.5"	10	33 mm	10	1 1/4" / 32 mm	1 1/4" / 32 mm	No	Steel/Aluminum	Hub Piloted
10138	20", 22.5", 24.5"	8	33 mm	8	1 1/4" / 32 mm	1 1/4" / 32 mm	No	Steel/Aluminum	Hub Piloted

Replacement Parts

- 10140** Chrome 2 1/2" Tall Dome Axle Hat/Cover Only, 2 Pcs. with Removable Hub Cap, without Beauty Ring
- 10152** Chrome 2 1/2" Tall Pointed Axle Hat/Cover Only, 2 Pcs. with Removable Hub Cap, without Beauty Ring
- 10203** Chrome Dome Hub Cap Only, without Beauty Ring or Axle Side Wall
- 10229** Chrome Pointed Hub Cap Only, without Beauty Ring or Axle Side Wall
- 10206** Chrome Hubdometer Hub Cap Only, without Beauty Ring or Axle Side Wall
- 10153** Chrome Axle Side Wall, without Beauty Ring or Hub Cap
- 10214** Chrome Beauty Ring Only for Item # 10121, 10124, 10127, 10 Holes, for Steel Stud Piloted Wheel
- 10215** Chrome Beauty Ring Only for Item # 10122, 10125, 10129, 10 Holes, Tapered, for Aluminum Stud Piloted Wheel
- 10218** Chrome Beauty Ring Only for Item # 10123, 10126, 10136, 10 Holes, Uni-Mount, for Steel or Aluminum Hub Piloted Wheel
- 10220** Chrome Beauty Ring Only for Item # 10130, 10137, 10138, 8 Holes, Uni-Mount, for Steel or Aluminum Hub Piloted Wheel

Recommended Accessories / Replacement Parts



10140



10152

Chrome 2 Piece Front Axle/Hub Hat - Hat Only

Description

- Chrome 2 1/2" Tall Front Axle/Hub Hat Only for 3 Piece Front Axle Cover
- 2 Piece Set, without Beauty Ring
- Available with Dome or Pointed Hub Cap

Item Number	Description	Cap Style	Pack
10140	2 1/2" Tall Dome Axle Hat	Dome	Bulk = 1 Set
10152	2 1/2" Tall Pointed Axle Hat	Pointed	Bulk = 1 Set



Chrome Front Axle Side Wall

Description

- Chrome Axle Side Wall for 3 Piece Front Axle Cover
- Axle Side Wall Only, without Beauty Ring or Hub Cap

Item Number	Description	Pack
10153	Front Axle Side Wall	Bulk = 1 Pc.

Recommended Accessories / Replacement Parts

Chrome Hub Caps

Description

- Chrome Hub Caps for 3 Piece Front Axle Cover
- Hub Cap Only, without Beauty Ring or Axle Side Wall
- Available in Dome, Pointed, or Hubdometer Style

Item Number	Description	Pack
10203	Dome Hub Cap	Bulk = 1 Pc.
10229	Pointed Hub Cap	Bulk = 1 Pc.
10206	Hubdometer Hub Cap	Bulk = 1 Pc.

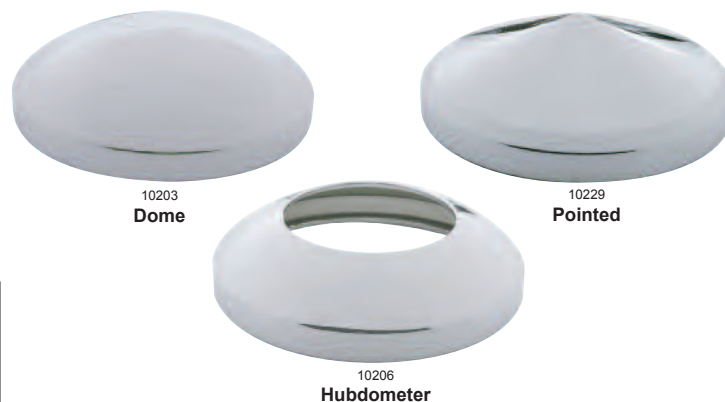

Chrome Beauty Ring - Beauty Ring Only

Description

- Chrome Beauty Ring Only for Front Axle Cover
- Without Hat, Fits Most 20", 22 1/2", and 24 1/2" Wheel
- Replacement Beauty Ring for United Pacific Front Axle Cover

Item Number	Replacement Ring For	Lug	Nut Size	Holes	Tapered	Wheel Type	Hub Type	Pack
10214	10121, 10124, 10127	10	1 1/2"	5 Big/5 Small	No	Steel	Stud Piloted	Bulk = 1 Pc.
10215	10122, 10125, 10129	10	1 1/2"	5 Big/5 Small	Yes	Aluminum	Stud Piloted	Bulk = 1 Pc.
10218	10123, 10126, 10136	10	33 mm	10	No	Steel/Aluminum	Hub Piloted	Bulk = 1 Pc.
10220	10130, 10137, 10138	8	33 mm	8	No	Steel/Aluminum	Hub Piloted	Bulk = 1 Pc.

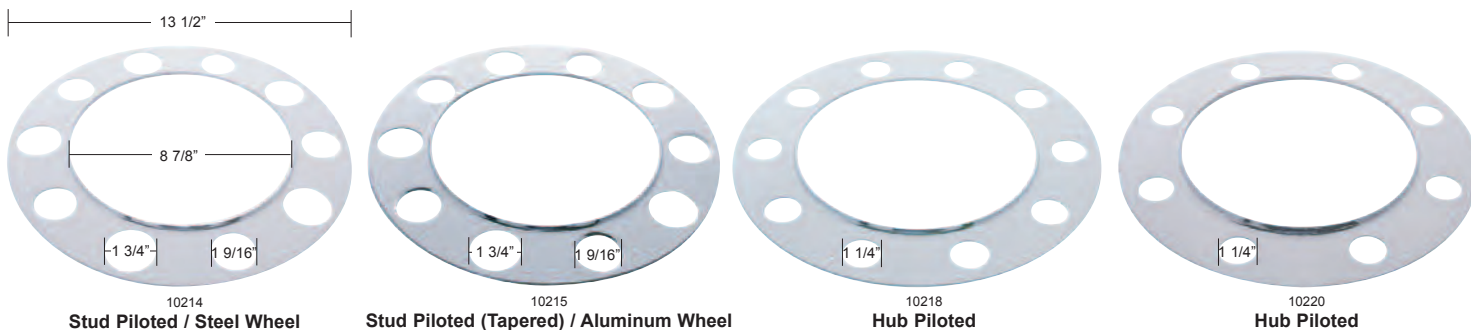

Plastic Rim Protector

Description

- Black Plastic Rim Protector
- 10 Lug Pattern with 1 7/8" Hole or 1" Hole
- Use 10128 to Protect the Rim when Removing or Installing Tire/Rim
- Use 10148 to Prevent Aluminum Wheels from Sticking Together

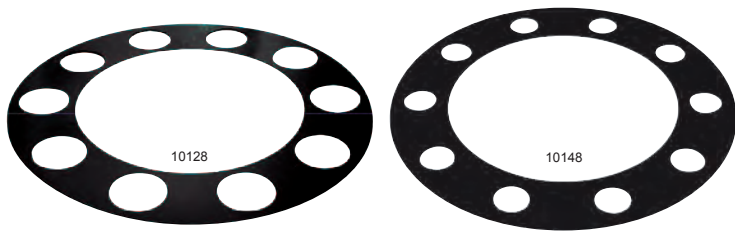

Item Number	Lug	Holes	O.D.	Pack
10128	10	1 7/8"	14"	Bulk = 1 Pc.
10148	10	1"	13 3/4"	Bulk = 1 Pc.

STUD PILOTED VS. HUB PILOTED

Stud Piloted -

Stud Piloted Wheel centers the wheel on the hub by the seating action of the ball seat nuts. Most Stud Piloted Wheels use 1 1/2" ball seat lug nuts. Stud Piloted Wheels are also commonly referred to as "Budds".

Hub Piloted -

Hub Piloted Wheel centers the wheel on the hub by the studs built around the center hole/hub. Hub Piloted Wheels typically use a 33mm flanged lug nut. Only one nut on each stud is used to fasten single or dual wheels to the vehicle. Hub Piloted Wheels are commonly referred to as "Unimounts".

Products Designed for the Hub Piloted Wheels typically have 10 lug holes, 5 holes with 1" diameter and 5 holes with 1 7/8" diameter. The 5 larger 1 7/8" diameter holes slip over existing lug nuts and permit installation without removal of all the lug nuts. Because the product is only secured to the Hub Piloted Wheels by 5 lug nuts, the above design might become loose after installation. To address this problem, United Pacific designed our Hub Piloted Wheel products with 10 equal 1 1/4" holes. Although installation of United Pacific products require the removal of all lug nuts, the utilization of all 10 lug nuts provides a much more secured attachment than our competitors.



Chrome Rear Axle Cover - 2 Piece Kit

Description

- Chrome Steel 2 Piece Rear Axle and Hub Cover
- Fits Most 20", 22 1/2", and 24 1/2" Wheel

Chrome Rear Axle Cover

Item Number	Fits Wheel	Lug	Nut Size	Holes	Large Hole	Small Hole	Tapered	Wheel Type	Hub Type
10210	20", 22.5", 24.5"	10	1 1/2"	5 Big/5 Small	1 3/4" / 44 mm	1 9/16" / 40 mm	No	Steel	Stud Piloted
10211	20", 22.5", 24.5"	10	1 1/2"	5 Big/5 Small	1 3/4" / 44 mm	1 9/16" / 40 mm	Yes	Aluminum	Stud Piloted
10223	20", 22.5", 24.5"	10	33 mm	10	1 1/4" / 32 mm	1 1/4" / 32 mm	No	Steel/Aluminum	Hub Piloted
10222	20", 22.5", 24.5"	8	33 mm	8	1 1/4" / 32 mm	1 1/4" / 32 mm	No	Steel/Aluminum	Hub Piloted

Replacement Parts

- 10216** Chrome Rear Axle High Hat/Cover Only, without Beauty Ring
- 10214** Chrome Beauty Ring Only for Item # 10210, 10 Holes, for Steel Stud Piloted Wheel
- 10215** Chrome Beauty Ring Only for Item # 10211, 10 Holes, Tapered, for Aluminum Stud Piloted Wheel
- 10218** Chrome Beauty Ring Only for Item # 10223, 10 Holes, Uni-Mount, for Steel or Aluminum Hub Piloted Wheel
- 10220** Chrome Beauty Ring Only for Item # 10222, 8 Holes, Uni-Mount, for Steel or Aluminum Hub Piloted Wheel

Recommended Accessories / Replacement Parts

Chrome Rear Axle/Hub High Hat - High Hat Only

Description

- Chrome Rear Axle/Hub High Hat Only
- Without Beauty Ring, for 2 Piece Rear Axle Kit



Item Number	Description	Pack
10216	Rear Axle High Hat	Bulk = 1 Pc.

Chrome Beauty Ring - Beauty Ring Only

Description

- Chrome Beauty Ring Only for Front Axle Cover
- Without Hat, Fits Most 20", 22 1/2", and 24 1/2" Wheel
- Replacement Beauty Ring for United Pacific Chrome Rear Axle Cover

Item Number	Description	Lug	Nut Size	Holes	Tapered	Wheel Type	Hub Type	Pack
10214	Beauty Ring for Item # 10131	10	1 1/2"	5 Big/5 Small	No	Steel	Stud Piloted	Bulk = 1 Pc.
10215	Beauty Ring for Item # 10132	10	1 1/2"	5 Big/5 Small	Yes	Aluminum	Stud Piloted	Bulk = 1 Pc.
10218	Beauty Ring for Item # 10133	10	33 mm	10	No	Steel/Aluminum	Hub Piloted	Bulk = 1 Pc.
10220	Beauty Ring for Item # 10134	8	33 mm	8	No	Steel/Aluminum	Hub Piloted	Bulk = 1 Pc.

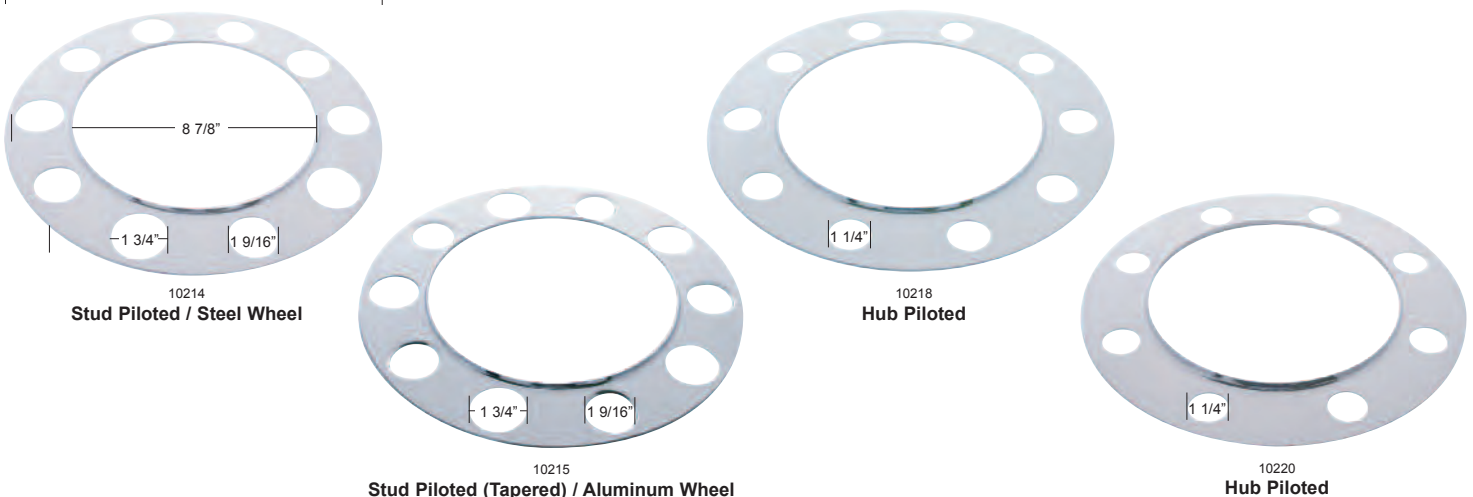



21210
Stud Piloted/Steel Wheel



21211
Stud Piloted/Aluminum Wheel



21223
Hub Piloted



21222
Hub Piloted

Stainless Rear Axle Cover

Stainless Steel Rear Axle Cover - 2 Piece Kit

Description

- Stainless Steel 2 Piece Rear Axle and Hub Cover
- Fits Most 20", 22 1/2", and 24 1/2" Wheel

Item Number	Fits Wheel	Lug	Nut Size	Holes	Large Hole	Small Hole	Tapered	Wheel Type	Hub Type
21210	20", 22.5", 24.5"	10	1 1/2"	5 Big/5 Small	1 3/4" / 44 mm	1 9/16" / 40 mm	No	Steel	Stud Piloted
21211	20", 22.5", 24.5"	10	1 1/2"	5 Big/5 Small	1 3/4" / 44 mm	1 9/16" / 40 mm	Yes	Aluminum	Stud Piloted
21223	20", 22.5", 24.5"	10	33 mm	10	1 1/4" / 32 mm	1 1/4" / 32 mm	No	Steel/Aluminum	Hub Piloted
21222	20", 22.5", 24.5"	8	33 mm	8	1 1/4" / 32 mm	1 1/4" / 32 mm	No	Steel/Aluminum	Hub Piloted

Replacement Parts

- 21216** Stainless Steel Rear Axle High Hat/Cover Only, without Beauty Ring
- 21214** Stainless Steel Beauty Ring Only for Item # 21210, 10 Holes, for Steel Stud Piloted Wheel
- 21215** Stainless Steel Beauty Ring Only for Item # 21211, 10 Holes, Tapered, for Aluminum Stud Piloted Wheel
- 21218** Stainless Steel Beauty Ring Only for Item # 21223, 10 Holes, Uni-Mount, for Steel or Aluminum Hub Piloted Wheel
- 21219** Stainless Steel Beauty Ring Only for Item # 21222, 8 Holes, Uni-Mount, for Steel or Aluminum Hub Piloted Wheel

Recommended Accessories / Replacement Parts



Stainless Steel Rear Axle/Hub High Hat - High Hat Only

Description

- Stainless Steel Rear Axle/Hub High Hat Only
- Without Beauty Ring, for 2 Piece Rear Axle Kit

Item Number	Description	Pack
21216	Rear Axle High Hat	Bulk = 1 Pc.

Stainless Steel Beauty Ring - Beauty Ring Only

Description

- Stainless Steel Beauty Ring Only for Front Axle Cover
- Without Hat, Fits Most 20", 22 1/2", and 24 1/2" Wheel
- Replacement Beauty Ring for United Pacific Stainless Steel Rear Axle Cover

Item Number	Description	Lug	Nut Size	Holes	Tapered	Wheel Type	Hub Type	Pack
21214	Beauty Ring for Item # 21210	10	1 1/2"	5 Big/5 Small	No	Steel	Stud Piloted	Bulk = 1 Pc.
21215	Beauty Ring for Item # 21211	10	1 1/2"	5 Big/5 Small	Yes	Aluminum	Stud Piloted	Bulk = 1 Pc.
21218	Beauty Ring for Item # 21223	10	33 mm	10	No	Steel/Aluminum	Hub Piloted	Bulk = 1 Pc.
21219	Beauty Ring for Item # 21222	8	33 mm	8	No	Steel/Aluminum	Hub Piloted	Bulk = 1 Pc.

13 1/2"

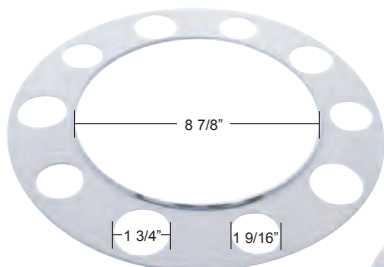

21214
Stud Piloted / Steel Wheel

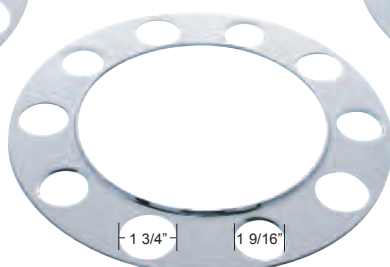

21215
Stud Piloted (Tapered) / Aluminum Wheel

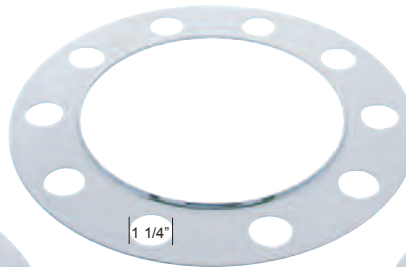

21218
Hub Piloted

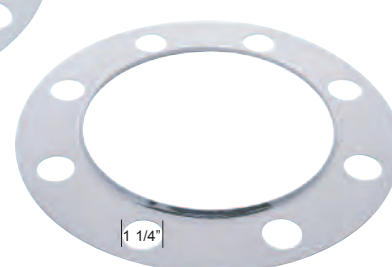

21219
Hub Piloted



10212
Stud Piloted / Dome



10224
Stud Piloted / Pointed



10221
Hub Piloted / Dome



10251
Hub Piloted / Pointed

Chrome Rear Axle Cover - 3 Piece Kit

Description

- Chrome Steel 3 Piece Rear Axle and Hub Cover with Removable Hub Cap
- Fits Most 20", 22 1/2", and 24 1/2" Wheel
- Hub Cap available in Dome or Pointed Style

Chrome Rear Axle Cover

Chrome Rear Axle Cover - Dome

Item Number	Fits Wheel	Lug	Nut Size	Holes	Large Hole	Small Hole	Tapered	Wheel Type	Hub Type
10212	20", 22.5", 24.5"	10	1 1/2"	5 Big/5 Small	1 3/4" / 44 mm	1 9/16" / 40 mm	No	Steel	Stud Piloted
10213	20", 22.5", 24.5"	10	1 1/2"	5 Big/5 Small	1 3/4" / 44 mm	1 9/16" / 40 mm	Yes	Aluminum	Stud Piloted
10221	20", 22.5", 24.5"	10	33 mm	10	1 1/4" / 32 mm	1 1/4" / 32 mm	No	Steel/Aluminum	Hub Piloted
10250	20", 22.5", 24.5"	8	33 mm	8	1 1/4" / 32 mm	1 1/4" / 32 mm	No	Steel/Aluminum	Hub Piloted

Chrome Rear Axle Cover - Pointed

Item Number	Fits Wheel	Lug	Nut Size	Holes	Large Hole	Small Hole	Tapered	Wheel Type	Hub Type
10224	20", 22.5", 24.5"	10	1 1/2"	5 Big/5 Small	1 3/4" / 44 mm	1 9/16" / 40 mm	No	Steel	Stud Piloted
10225	20", 22.5", 24.5"	10	1 1/2"	5 Big/5 Small	1 3/4" / 44 mm	1 9/16" / 40 mm	Yes	Aluminum	Stud Piloted
10226	20", 22.5", 24.5"	10	33 mm	10	1 1/4" / 32 mm	1 1/4" / 32 mm	No	Steel/Aluminum	Hub Piloted
10251	20", 22.5", 24.5"	8	33 mm	8	1 1/4" / 32 mm	1 1/4" / 32 mm	No	Steel/Aluminum	Hub Piloted

Replacement Parts

- 10217 Chrome Dome High Hat/Cover Only, 2 Pc. with Removable Dome Hub Cap, without Beauty Ring
- 10248 Chrome Pointed High Hat/Cover Only, 2 Pc. with Removable Pointed Hub Cap, without Beauty Ring
- 10203 Chrome Dome Hub Cap Only, without Beauty Ring or Axle Side Wall
- 10229 Chrome Pointed Hub Cap Only, without Beauty Ring or Axle Side Wall
- 10214 Chrome Beauty Ring Only for Item # 10212, 10224, 10 Holes, for Steel Stud Piloted Wheel
- 10215 Chrome Beauty Ring Only for Item # 10213, 10225, 10 Holes, Tapered for Aluminum Stud Piloted Wheel
- 10218 Chrome Beauty Ring Only for Item # 10221, 10226, 10 Holes, Uni-Mount for Steel or Aluminum Hub Piloted Wheel
- 10220 Chrome Beauty Ring Only for Item # 10250, 10251, 8 Holes, Uni-Mount for Steel or Aluminum Hub Piloted Wheel

Recommended Accessories / Replacement Parts

Chrome 2 Piece Rear Axle/Hub High Hat - High Hat Only

Description

- Chrome Rear Axle/Hub High Hat Only with Removable Cap
- 2 Piece Set, without Beauty Ring
- Available with Dome or Pointed Hub Cap

Item Number	Description	Pack
10217	Dome Rear Axle High Hat/Cover	Bulk = 1 Set
10248	Pointed Rear Axle High Hat/Cover	Bulk = 1 Set



10217
Dome



10248
Pointed

Chrome Hub Caps

Description

- Chrome Hub Caps for 3 Piece Rear Axle Cover
- Hub Cap Only, without Beauty Ring or Axle Side Wall
- Available in Dome or Pointed Style

Item Number	Description	Pack
10203	Dome Hub Cap	Bulk = 1 Set
10229	Pointed Hub Cap	Bulk = 1 Set



10203
Dome



10229
Pointed



21212
Stud Piloted / Dome



21225
Stud Piloted / Pointed



21221
Hub Piloted / Dome



21227
Hub Piloted / Pointed

Stainless Steel Rear Axle Cover - 3 Piece Kit

Description

- Stainless Steel 3 Piece Rear Axle and Hub Cover with Removable Hub Cap
- Fits Most 20", 22 1/2", and 24 1/2" Wheel
- Hub Cap Available in Dome or Pointed Style

Stainless Rear Axle Cover

Stainless Steel Rear Axle Cover - Dome

Item Number	Fits Wheel	Lug	Nut Size	Holes	Large Hole	Small Hole	Tapered	Wheel Type	Hub Type
21212	20", 22.5", 24.5"	10	1 1/2"	5 Big/5 Small	1 3/4" / 44 mm	1 9/16" / 40 mm	No	Steel	Stud Piloted
21213	20", 22.5", 24.5"	10	1 1/2"	5 Big/5 Small	1 3/4" / 44 mm	1 9/16" / 40 mm	Yes	Aluminum	Stud Piloted
21221	20", 22.5", 24.5"	10	33 mm	10	1 1/4" / 32 mm	1 1/4" / 32 mm	No	Steel/Aluminum	Hub Piloted
21228	20", 22.5", 24.5"	8	33 mm	8	1 1/4" / 32 mm	1 1/4" / 32 mm	No	Steel/Aluminum	Hub Piloted

Stainless Steel Rear Axle Cover - Pointed

Item Number	Fits Wheel	Lug	Nut Size	Holes	Large Hole	Small Hole	Tapered	Wheel Type	Hub Type
21224	20", 22.5", 24.5"	10	1 1/2"	5 Big/5 Small	1 3/4" / 44 mm	1 9/16" / 40 mm	No	Steel	Stud Piloted
21225	20", 22.5", 24.5"	10	1 1/2"	5 Big/5 Small	1 3/4" / 44 mm	1 9/16" / 40 mm	Yes	Aluminum	Stud Piloted
21226	20", 22.5", 24.5"	10	33 mm	10	1 1/4" / 32 mm	1 1/4" / 32 mm	No	Steel/Aluminum	Hub Piloted
21227	20", 22.5", 24.5"	8	33 mm	8	1 1/4" / 32 mm	1 1/4" / 32 mm	No	Steel/Aluminum	Hub Piloted

Replacement Parts

- 21217 Stainless Steel Dome High Hat/Cover Only, 2 Pc. with Removable Hub Cap, without Beauty Ring
- 21209 Stainless Steel Pointed High Hat/Cover Only, 2 Pc. with Removable Hub Cap, without Beauty Ring
- 20203 Stainless Steel Dome Hub Cap Only, without Beauty Ring or Axle Side Wall
- 20190 Stainless Steel Pointed Hub Cap Only, without Beauty Ring or Axle Side Wall
- 21214 Stainless Steel Beauty Ring Only for Item # 21212, 21224, 10 Holes, for Steel Stud Piloted Wheel
- 21215 Stainless Steel Beauty Ring Only for Item # 21213, 21225, 10 Holes, Tapered for Aluminum Stud Piloted Wheel
- 21218 Stainless Steel Beauty Ring Only for Item # 21221, 21226, 10 Holes, Uni-Mount for Steel or Aluminum Hub Piloted Wheel
- 21219 Stainless Steel Beauty Ring Only for Item # 21228, 21227, 8 Holes, Uni-Mount for Steel or Aluminum Hub Piloted Wheel

Recommended Accessories / Replacement Parts

Stainless 2 Piece Rear Axle/Hub High Hat - High Hat Only

Description

- Stainless Steel Rear Axle/Hub High Hat Only with Removable Cap
- 2 Piece Set, without Beauty Ring
- Available with Dome or Pointed Hub Cap

Item Number	Description	Pack
21217	Dome Rear Axle High Hat/Cover	Bulk = 1 Set
21209	Pointed Rear Axle High Hat/Cover	Bulk = 1 Set



21217
Dome



21209
Pointed

Stainless Steel Hub Caps

Description

- Stainless Steel Hub Caps for 3 Piece Rear Axle Cover
- Hub Cap Only, without Beauty Ring or Axle Side Wall
- Available in Dome or Pointed Style

Item Number	Description	Pack
20203	Dome Hub Cap	Bulk = 1 Set
20190	Pointed Hub Cap	Bulk = 1 Set



20203
Dome



20190
Pointed

Unitized Stainless Steel Rear Axle Cover - 2 Piece Kit

Description

- Stainless Steel Unitized 2 Piece Rear Axle Cover with Removable Hub Cap, No Beauty Ring Required
- The Beauty Ring and the Rear Axle Side Wall are Manufactured as a Single Unit, Similar in Design as the Chrome Plastic Rear Axle Covers
- Fits Most 20", 22 1/2", and 24 1/2" Wheel

Item Number	Fits Wheel	Lug	Nut Size	Holes	Large Hole	Small Hole	Tapered	Wheel Type	Hub Type
21220	20", 22.5", 24.5"	10	1 1/2"	5 Big/5 Small	1 13/16" / 46 mm	1 1/2" / 39 mm	No	Steel	Stud Piloted



Recommended Accessories / Replacement Parts

Stainless Steel Unitized Rear Hub Cap

Description

- Stainless Steel Rear Hub Cap for United Pacific Unitized Rear Axle Cover
- Replacement Hub Cap Only

Item Number	Description	Pack
21220-1	Replacement Hub Cap for 21220	Bulk = 1 Pc.



WHAT'S HOT

Chrome Spike Gearshift Knob - Vertical

Description

- Chrome Spike Gearshift Knob, Vertical Mount
- Fits 13/18 Speed Gearshift Knobs, CNC-Machined Grip
- Mounting Adaptor (UP Item # 70604B), "Daytona" Spike Grip (UP Item # 70601B) & "Talladega" Spike Grip (UP Item # 70621B) Available Separately
- ***Patent Pending***

Item Number	Description	Speed	Pack
70609	"Daytona" Gearshift Knob	13/18	1 Pc./Box
70628	"Talladega" Gearshift Knob	13/18	1 Pc./Box

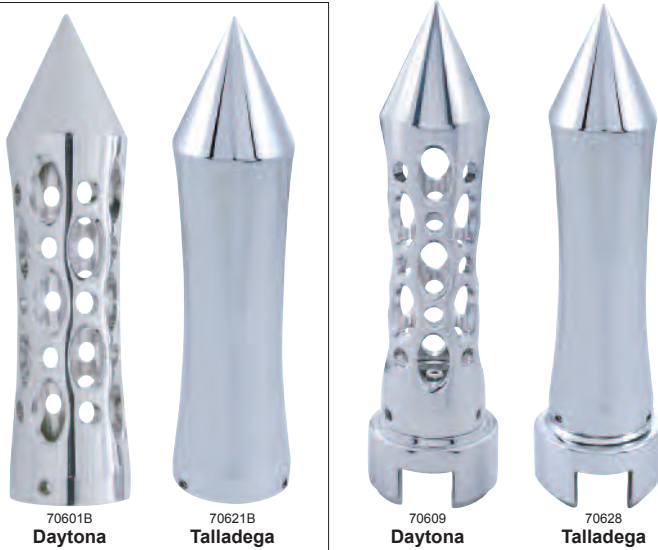

Chrome Spike Grip

Description

- Chrome Aluminum Spike Grip
- CNC-Machined Grip, 1" Round Opening, Hex Screw Mount
- Mounting Adaptor (UP Item # 70600B & UP Item # 70604B) Available Separately

Item Number	Description	Speed	Pack
70601B	"Daytona" Spike Grip	13/18	1 Pc./Box
70621B	"Talladega" Spike Grip	13/18	1 Pc./Box

Chrome Spike Gearshift Knob

Description

- Chrome Spike Gearshift Knob, CNC-Machined Grip
- Fits 13/18 Speed Gearshift Knobs
- Mounting Adaptor (UP Item # 70600B), "Daytona" Spike Grip (UP Item # 70601B) & "Talladega" Spike Grip (UP Item # 70621B) Available Separately
- ***Patent Pending***

Item Number	Description	Speed	Pack
70607	"Daytona" Gearshift Knob	13/18	1 Pc./Box
70627	"Talladega" Gearshift Knob	13/18	1 Pc./Box

Patent Pending



BEAUTY RINGS

Beauty Rings

Description

- Chrome or Stainless Steel Beauty Rings
- Fits Most 20", 22 1/2", and 24 1/2" Wheel, for Front and Rear Wheel Applications

Chrome Beauty Ring

Item Number	Fits Wheel	Lug	Nut Size	Holes	Large Hole	Small Hole	Tapered	Wheel Type	Hub Type
10214	20", 22.5", 24.5"	10	1 1/2"	5 Big/5 Small	1 3/4" / 44 mm	1 9/16" / 40 mm	No	Steel	Stud Piloted
10215	20", 22.5", 24.5"	10	1 1/2"	5 Big/5 Small	1 3/4" / 44 mm	1 9/16" / 40 mm	Yes	Aluminum	Stud Piloted
10218	20", 22.5", 24.5"	10	33 mm	10	1 1/4" / 32 mm	1 1/4" / 32 mm	No	Steel/Aluminum	Hub Piloted
10220	20", 22.5", 24.5"	8	33 mm	8	1 1/4" / 32 mm	1 1/4" / 32 mm	No	Steel/Aluminum	Hub Piloted

Stainless Beauty Ring

Item Number	Fits Wheel	Lug	Nut Size	Holes	Large Hole	Small Hole	Tapered	Wheel Type	Hub Type
21214	20", 22.5", 24.5"	10	1 1/2"	5 Big/5 Small	1 3/4" / 44 mm	1 9/16" / 40 mm	No	Steel	Stud Piloted
21215	20", 22.5", 24.5"	10	1 1/2"	5 Big/5 Small	1 3/4" / 44 mm	1 9/16" / 40 mm	Yes	Aluminum	Stud Piloted
21218	20", 22.5", 24.5"	10	33 mm	10	1 1/4" / 32 mm	1 1/4" / 32 mm	No	Steel/Aluminum	Hub Piloted
21219	20", 22.5", 24.5"	8	33 mm	8	1 1/4" / 32 mm	1 1/4" / 32 mm	No	Steel/Aluminum	Hub Piloted

13 1/2"

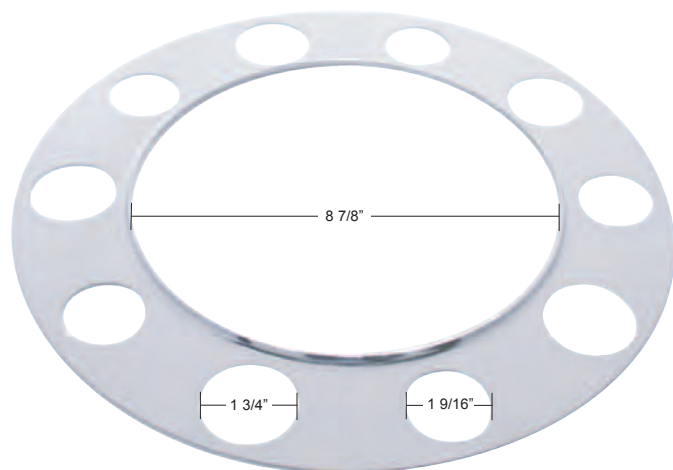

Stud Piloted / Steel Wheel

10214/21214

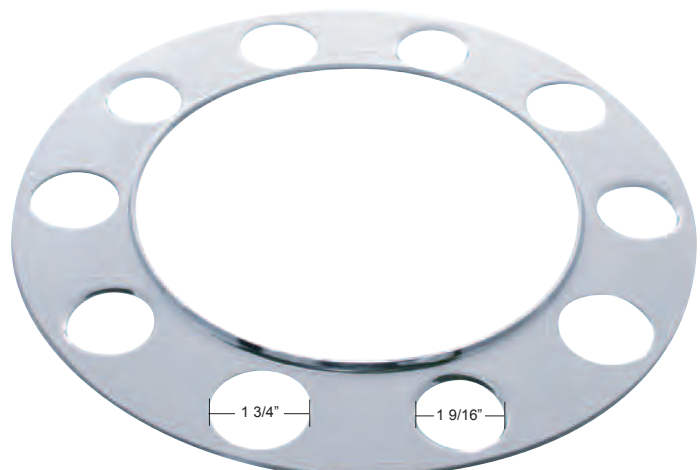

Stud Piloted (Tapered) / Aluminum Wheel

10215/21215

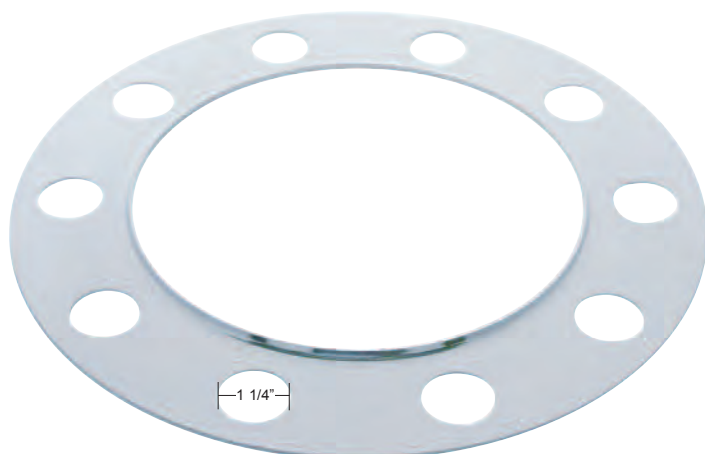

Hub Piloted

10218/21218



Hub Piloted

10220/21219



WHEEL SIMULATORS

Stainless Steel Front Wheel Simulator Set

Description

- Stainless Steel Front Wheel Simulator Set
- Simulator Set Includes 2 Front Wheel Covers, 2 Front Hub Caps, and 20 Nut Covers

Item Number	O.D.	I.D.	Hand/Vent Hole	Lug	Nut Size	Holes	Large Hole	Small Hole	Hub Type
20302	24 1/2"	8 1/4"	2	10	1 1/2"	5 Big/5 Small	1 7/8" / 47 mm	1 1/2" / 39 mm	Stud Piloted
20311	24 1/2"	8 1/4"	5	10	1 1/2"	5 Big/5 Small	1 7/8" / 47 mm	1 1/2" / 39 mm	Stud Piloted
20305	22 1/2"	8 1/4"	2	10	1 1/2"	5 Big/5 Small	1 7/8" / 47 mm	1 1/2" / 39 mm	Stud Piloted
20308	22 1/2"	8 1/4"	5	10	1 1/2"	5 Big/5 Small	1 7/8" / 47 mm	1 1/2" / 39 mm	Stud Piloted
20315	22 1/2"	8 1/4"	2	10	33 mm	10	1 1/4" / 32 mm	1 1/4" / 32 mm	Hub Piloted
20317	22 1/2"	8 1/4"	5	10	33 mm	10	1 1/4" / 32 mm	1 1/4" / 32 mm	Hub Piloted

Item Number	Kit Components	Description	Quantity in Kit
20302	10080	Stainless Steel 1 1/2" Nut Cover	20
	20106	Stainless Steel 4 Notched Front Hub Cap	2
	20348	Stainless Steel 24 1/2" Stud Piloted Front Wheel Cover (2 Hand/Vent Holes)	2
20311	10080	Stainless Steel 1 1/2" Nut Cover	20
	20106	Stainless Steel 4 Notched Front Hub Cap	2
	20358	Stainless Steel 24 1/2" Stud Piloted Front Wheel Cover (5 Hand/Vent Holes)	2
20305	10080	Stainless Steel 1 1/2" Nut Cover	20
	20106	Stainless Steel 4 Notched Front Hub Cap	2
	20349	Stainless Steel 22 1/2" Stud Piloted Front Wheel Cover (2 Hand/Vent Holes)	2
20308	10080	Stainless Steel 1 1/2" Nut Cover	20
	20106	Stainless Steel 4 Notched Front Hub Cap	2
	20351	Stainless Steel 22 1/2" Stud Piloted Front Wheel Cover (5 Hand/Vent Holes)	2
20315	10081	Stainless Steel 33mm Nut Cover	20
	20106	Stainless Steel 4 Notched Front Hub Cap	2
	20352	Stainless Steel 22 1/2" Hub Piloted Front Wheel Cover (2 Hand/Vent Holes)	2
20317	10081	Stainless Steel 33mm Nut Cover	20
	20106	Stainless Steel 4 Notched Front Hub Cap	2
	20353	Stainless Steel 22 1/2" Hub Piloted Front Wheel Cover (5 Hand/Vent Holes)	2



20302
24 1/2" O.D.
2 Hand/Vent Holes
Stud Piloted



20311
24 1/2" O.D.
5 Hand/Vent Holes
Stud Piloted



20305
22 1/2" O.D.
2 Hand/Vent Holes
Stud Piloted



20308
22 1/2" O.D.
5 Hand/Vent Holes
Stud Piloted



20315
22 1/2" O.D.
2 Hand/Vent Holes
Hub Piloted



20317
22 1/2" O.D.
5 Hand/Vent Holes
Hub Piloted

Recommended Accessories / Replacement Parts

Stainless Steel Front Wheel Cover

Description

- Stainless Steel Front Wheel Cover
- Covers the Entire Front Wheel, Sold: **Bulk = 1 Pc.**

Item Number	O.D.	I.D.	Hand/Vent Hole	Lug	Nut Size	Holes	Large Hole	Small Hole	Hub Type
20348	24 1/2"	8 1/4"	2	10	1 1/2"	5 Big/5 Small	1 7/8" / 47 mm	1 1/2" / 39 mm	Stud Piloted
20350	24 1/2"	8 1/4"	5	10	1 1/2"	5 Big/5 Small	1 7/8" / 47 mm	1 1/2" / 39 mm	Stud Piloted
20349	22 1/2"	8 1/4"	2	10	1 1/2"	5 Big/5 Small	1 7/8" / 47 mm	1 1/2" / 39 mm	Stud Piloted
20351	22 1/2"	8 1/4"	5	10	1 1/2"	5 Big/5 Small	1 7/8" / 47 mm	1 1/2" / 39 mm	Stud Piloted
20352	22 1/2"	8 1/4"	2	10	33 mm	10	1 1/4" / 32 mm	1 1/4" / 32 mm	Hub Piloted
20353	22 1/2"	8 1/4"	5	10	33 mm	10	1 1/4" / 32 mm	1 1/4" / 32 mm	Hub Piloted



20348
24 1/2" O.D.
2 Hand/Vent Holes
Stud Piloted



20350
24 1/2" O.D.
5 Hand/Vent Holes
Stud Piloted



20349
22 1/2" O.D.
2 Hand/Vent Holes
Stud Piloted



20351
22 1/2" O.D.
5 Hand/Vent Holes
Stud Piloted



20352
22 1/2" O.D.
2 Hand/Vent Holes
Hub Piloted



20353
22 1/2" O.D.
5 Hand/Vent Holes
Hub Piloted

Stainless Steel Hub Cap

Description

- Stainless Steel 4 Even Notched Front Hub Cap with 7/16" Lip

Item Number	Description	Pack	Case
20106	4 Notched Front Hub Cap	Bulk = 1 Pc.	40/Case



Stainless Steel Nut Cover

Description

- Stainless Steel 1 1/2" or 33mm Nut Cover for United Pacific Front Simulators

Item Number	Description	Pack	Case
10080	1 1/2" Nut Cover	Bulk = 1 Pc.	500/Case
10081	33 mm Nut Cover	Bulk = 1 Pc.	500/Case



10080



10081

Stainless Steel Front Wheel Cover - OEM Style

Description

- Stainless Steel OEM Style Front Wheel Cover
- 20115 is the Economy Version of 20117
- Sold: **Bulk = 1 Pc.**

Item Number	O.D.	Holes	Large Hole	Small Hole
20116	24 1/2"	5 Big/5 Small	1 7/8" / 47 mm	1 1/2" / 39 mm
20117	22 1/2"	5 Big/5 Small	1 7/8" / 47 mm	1 1/2" / 39 mm



Stainless Steel Rear Wheel Simulator Set

Description

- Stainless Steel Rear Wheel Simulator Set
- Simulator Set Includes 2 Rear Wheel Cover, 2 Rear Hub and Axle Covers, and 20 Nut Covers
- Available in 24 1/2" or 22 1/2" for Stud Piloted or Hub Piloted Wheels

Item Number	O.D.	I.D.	Hand/Vent Hole	Lug	Nut Size	Holes	Large Hole	Small Hole	Hub Type
20303	24 1/2"	8 1/4"	2	10	1 1/2"	5 Big/5 Small	1 7/8" / 47 mm	1 1/2" / 39 mm	Stud Piloted
20312	24 1/2"	8 1/4"	5	10	1 1/2"	5 Big/5 Small	1 7/8" / 47 mm	1 1/2" / 39 mm	Stud Piloted
20306	22 1/2"	8 1/4"	2	10	1 1/2"	5 Big/5 Small	1 7/8" / 47 mm	1 1/2" / 39 mm	Stud Piloted
20309	22 1/2"	8 1/4"	5	10	1 1/2"	5 Big/5 Small	1 7/8" / 47 mm	1 1/2" / 39 mm	Stud Piloted
20314	22 1/2"	8 1/4"	2	10	33 mm	10	1 1/4" / 32 mm	1 1/4" / 32 mm	Hub Piloted
20313	22 1/2"	8 1/4"	5	10	33 mm	10	1 1/4" / 32 mm	1 1/4" / 32 mm	Hub Piloted

Item Number	Kit Components	Description	Quantity in Kit
20303	10080	Stainless Steel 1 1/2" Nut Cover	20
	21220	Stainless Steel Unitized Rear Axle Cover	2
	20356	Stainless Steel 24 1/2" Stud Piloted Rear Wheel Cover (2 Hand/Vent Holes)	2
20312	10080	Stainless Steel 1 1/2" Nut Cover	20
	21220	Stainless Steel Unitized Rear Axle Cover	2
	20358	Stainless Steel 24 1/2" Stud Piloted Rear Wheel Cover (5 Hand/Vent Holes)	2
20306	10080	Stainless Steel 1 1/2" Nut Cover	20
	21220	Stainless Steel Unitized Rear Axle Cover	2
	20357	Stainless Steel 22 1/2" Stud Piloted Rear Wheel Cover (2 Hand/Vent Holes)	2
20309	10080	Stainless Steel 1 1/2" Nut Cover	20
	21220	Stainless Steel Unitized Rear Axle Cover	2
	20359	Stainless Steel 22 1/2" Stud Piloted Rear Wheel Cover (5 Hand/Vent Holes)	2
20314	10081	Stainless Steel 33mm Nut Cover	20
	21217	Stainless Steel Dome Rear Axle High Hat	2
	21218	Stainless Steel Uni-Mount 10 Hole Beauty Ring	2
	20355	Stainless Steel 22 1/2" Hub Piloted Rear Wheel Cover (2 Hand/Vent Holes)	2
20313	10081	Stainless Steel 33mm Nut Cover	20
	21217	Stainless Steel Dome Rear Axle High Hat	2
	21218	Stainless Steel Uni-Mount 10 Hole Beauty Ring	2
	20354	Stainless Steel 22 1/2" Hub Piloted Rear Wheel Cover (5 Hand/Vent Holes)	2



20303
24 1/2" O.D.
2 Hand/Vent Holes
Stud Piloted



20312
24 1/2" O.D.
5 Hand/Vent Holes
Stud Piloted



20306
22 1/2" O.D.
2 Hand/Vent Holes
Stud Piloted



20309
22 1/2" O.D.
5 Hand/Vent Holes
Stud Piloted



20314
22 1/2" O.D.
2 Hand/Vent Holes
Hub Piloted



20313
22 1/2" O.D.
5 Hand/Vent Holes
Hub Piloted

Recommended Accessories / Replacement Parts

Stainless Steel Rear Wheel Cover

Description

- Stainless Steel Rear Wheel Cover
- Covers the Entire Rear Wheel, Sold: Bulk = 1 Pc.

Item Number	O.D.	I.D.	Hand/Vent Hole	Lug	Nut Size	Holes	Large Hole	Small Hole	Hub Type
20356	24 1/2"	8 1/4"	2	10	1 1/2"	5 Big/5 Small	1 7/8" / 47 mm	1 1/2" / 39 mm	Stud Piloted
20358	24 1/2"	8 1/4"	5	10	1 1/2"	5 Big/5 Small	1 7/8" / 47 mm	1 1/2" / 39 mm	Stud Piloted
20357	22 1/2"	8 1/4"	2	10	1 1/2"	5 Big/5 Small	1 7/8" / 47 mm	1 1/2" / 39 mm	Stud Piloted
20359	22 1/2"	8 1/4"	5	10	1 1/2"	5 Big/5 Small	1 7/8" / 47 mm	1 1/2" / 39 mm	Stud Piloted
20355	22 1/2"	8 1/4"	2	10	33 mm	10	1 1/4" / 32 mm	1 1/4" / 32 mm	Hub Piloted
20354	22 1/2"	8 1/4"	5	10	33 mm	10	1 1/4" / 32 mm	1 1/4" / 32 mm	Hub Piloted



Stainless Steel Beauty Ring

Description

- Stainless Steel Beauty Ring for Hub Piloted Wheel
- Fits Most 20", 22 1/2", and 24 1/2" Wheel, Bolt Pattern 11 1/4" Center to Center

Item Number	Fits Wheel	Lug	Nut Size	Holes	Large Hole	Small Hole	Tapered	Wheel Type	Hub Type
21218	20", 22.5", 24.5"	10	33 mm	10	1 1/4" / 32 mm	1 1/4" / 32 mm	No	Steel/Aluminum	Hub Piloted

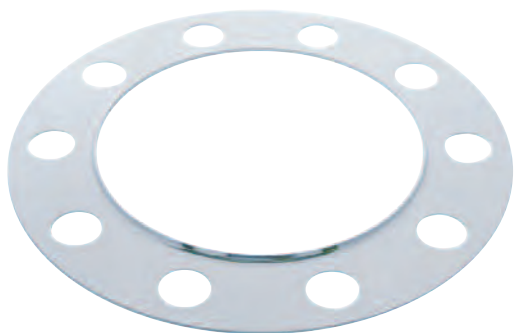

Unitized Stainless Steel Rear Axle Cover - 2 Piece Kit

Description

- Stainless Steel Unitized 2 Piece Rear Axle Cover with Removable Hub Cap
- No Beauty Ring Required, the Beauty Ring and the Rear Axle Side Wall are Manufactured as a Single Unit Similar in Design as the Chrome Plastic Rear Axle Covers
- Fits Most 20", 22 1/2", and 24 1/2" Wheel

Item Number	Fits Wheel	Lug	Nut Size	Holes	Large Hole	Small Hole	Tapered	Wheel Type	Hub Type
21220	20", 22.5", 24.5"	10	1 1/2"	5 Big/5 Small	1 13/16" / 46 mm	1 1/2" / 39 mm	No	Steel	Stud Piloted



Stainless Steel Nut Cover

Description

- Stainless Steel Nut Cover for United Pacific Front Simulator Set
- Available in 1 1/2" or 33 mm, Sold Each

Item Number	Description	Pack	Case
10080	1 1/2" Nut Cover	Bulk = 1 Pc.	500/Case
10081	33 mm Nut Cover	Bulk = 1 Pc.	500/Case

WHAT'S HOT

7" Round Headlight



31354
16 High Power LED



31387
Crystal H4 Halogen



31380
10 LED Crystal H4 Halogen



31378
34 LED Crystal H4 Halogen
- Amber LED



31379
34 LED Crystal H4 Halogen
- White LED

6" x 4" Rectangular Headlight

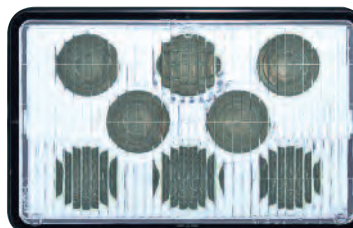

31358
6" x 4" High Power LED Headlight
- Low Beam Only

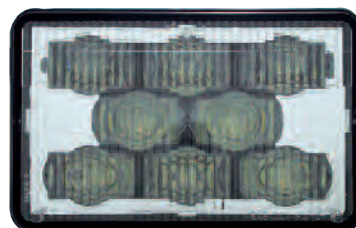

31359
6" x 4" High Power LED Headlight
- High Beam Only



31375
6" x 4" Crystal Projection Headlight
- Low Beam Only



31376
6" x 4" Crystal Projection Headlight
- High Beam Only



31388 - High & Low Beam, 31374 - High Beam
6" x 4" Crystal Headlight



31381 - High & Low Beam, 31382 - High Beam
6" x 4" Crystal Headlight w/ Blue Dot



31373 - Low Beam, 31374 - High Beam
9 LED 6" x 4" Rectangular Crystal
Headlight - Amber



31368 - Low Beam, 31369 - High Beam
9 LED 6" x 4" Rectangular Crystal
Headlight - White

TERMS & CONDITIONS / ORDERING GUIDELINES / FREIGHT

IMPORTANT: PLEASE REVIEW CAREFULLY

New Accounts

Initial minimum buy-in is \$2,000 (or to be determined by United Pacific Industries, UPI hereafter). All initial orders must be prepaid in advance by Cashier's Check or VISA/MC. All new/potential accounts must complete a UPI "New Customer Info/Credit Form" and follow the Dealer Qualification Instructions. Upon completion of the credit application, approved accounts will be assigned payment terms of NET 30 Days (from invoice date). Accounts denied a credit line will be required to prepay in advance by Cashier's Check or VISA/MC.

Payment Terms:

Term Accounts

Accounts with NET 30 Days terms are required to submit payment within the 30 days from the date of invoice. Acceptable forms of payment include checks, ACH (Automated Clearing House), or wire transfer.

A service charge of 1.5% per month will be imposed on invoices not paid within the 30 day term. Delinquent accounts will be required to pay Cash-In-Advance (CIA). Checks will be accepted but orders will not be released until the check is cleared by the bank. Past due invoices will delay current orders. Please check with UPI on your account status when placing an order.

Credit Cards

Accounts denied credit terms may pay by Visa or MasterCard. Credit card will be charged upon shipment. Credit card payments will not be accepted once an order has been shipped. UPI does not accept American Express or Discover card.

COD

A \$9.00 fee will be assessed per COD box for all FedEx/UPS COD shipments. Truck COD shipment fees are to be determined later by trucking company.

Returned Checks:

A \$30 NSF(Non Sufficient Fund) fee will be assessed on each incidence a check is returned to UPI.

ORDERING GUIDELINES

Placing Orders: New orders may be placed by any of the following methods

1. Fax: (310) 638-6287
2. E-mail: sales@uapac.com

3. Telephone: In order to minimize errors, customers are encouraged to submit their orders by fax or email. Telephone orders should be limited to smaller orders such as add-ons to orders already submitted and/or fill-ins occurring between larger restocking orders.

Changes to Orders:

Whenever possible, revisions to orders - additions or deletions of items - should also be submitted via fax or email to reduce the possibility of errors.

Additions/Deletion of items will only be accepted within 48 hours after the initial order date and/or before 12:00PM on the date of the shipment.

Additions of items placed after the 48 hours time period will be considered a new order and adhere to a new order freight prepaid policy. Deletions of item cannot happen after the 48 hours time period and/or after 12:00PM on the date of the shipment. Please note additions and/or deletions of items will delay the shipment date.

Canceling Orders:

Cancellation of orders must be submitted via fax or email within 24 hours of the order date. If the order has already shipped it will be the customers responsibility to return the order at the customers own expense. A restocking fee may apply, please see "Return" policy for further detail.

Backorders:

Customers have the option of having their backorders shipped or cancelled. Backorders resulting from a freight prepaid qualifying order will be shipped freight prepaid. UPI reserves the right to cancel backorders that are 6 months or older from the initial invoice date.

Minimum Order:

A minimum order of \$50.00 is required. Orders below \$50.00 will be assessed a minimum order fee of \$10.00.

Packaging:

A 10% service charge will be added to orders with special packaging or UPC barcoding requirements.

Lead Times:

Standard lead time for all United Pacific orders is 1-3 business days from the receipt of the purchase order. Larger orders may require a lead time of up to 5 business days. Transit time of 3-5 business days must be considered when placing orders. UPI cannot be responsible for delays in shipment after an order leaves our warehouse. UPI will work to resolve delays with freight forwarding firms, however, delays do arise from time to time due to weather and unforeseen circumstances beyond UPI's control. Express order are exempted; please view Freight/Shipping Policy for further detail.

Order Confirmation:

United Pacific will acknowledge receipt of orders by email/fax/telephone within 1 business day of receipt. If confirmation is not received, please contact UPI to ensure your order was received.

FREIGHT

Prepaid Freight:

Stock orders between \$50 and \$999.99 (US Lower 48 States), **\$50 and \$2499.99 (Alaska and Hawaii)**, **\$50 and \$1499.99 (Canada)**, [all price net US\$], will be shipped FOB Carson, California. Stock orders of \$1,000 (US Lower 48 States), **\$2500 (Alaska and Hawaii)**, **\$1500 (Canada)**, [based on UPI current pricing], or more will be shipped Freight Prepaid Ground to a single location only. (See exception for Oversize Items*). *Express Air orders, Special Net Pricing orders, and Special Quote Pricing orders are excluded.* United Pacific reserves the right to select the carrier of our choice. Customers may select the carrier of their choice at their own expense, negotiated rates and insurance. If customers elect to choose their own freight carrier, orders will be shipped via FREIGHT COLLECT.

***Oversize Item Freight Policy** - Applies to PB 379 Front Fenders, 60" or longer exhaust, and 18" or longer Saddle Boxes. 2 Options:

1. Freight will be prepaid by United Pacific if the total order of all items exceeds \$4,000 (US Lower 48 States) or **\$5000 (Hawaii, Alaska and Canada)**, [all price net US\$]. There will not be additional charges for these items included on the order.
2. Freight will be prepaid by United Pacific if a customer orders a total of \$2,500 (US Lower 48 States) or **\$3500 (Hawaii, Alaska and Canada)**, [all price net US\$], of PB 379 fenders, 60" or longer exhaust, and/or 18"+ Longer Saddle Boxes only. If the order is below \$2,500 (US Lower 48 States) or **\$3500 (Hawaii, Alaska and Canada)**, United Pacific will add freight charges to the order for the oversize items.

Will Call Orders:

Will Call orders can be picked up 2 - 4 hours after placing the order. Customers should always call ahead to confirm when order will be ready to pick up.

SHIPPING POLICY / CLAIMS

IMPORTANT: PLEASE REVIEW CAREFULLY

SHIPPING POLICY

International Shipments:

Shipments to locations outside the continental United States will be shipped to the customer's shipping agent or broker within the continental United States in accordance with the US freight policy. International customers will be responsible for the duties and taxes of their respective country.

Express Orders:

All express orders, such as Next Day, Second Day, 3 Day Service & Will Call, must be faxed/emailed. Order confirmation will be faxed to the customer for final approval. If confirmation is not received, please contact UPI to ensure your order was received. Customers are required to sign off on express orders and fax confirmation back to UPI. Cut off for express order is 12:00PM. Express orders received after 12:00PM may or may not ship the same day. Please call UPI to confirm projected shipping date or will call time.

Due to the high cost of express shipments, customer may request UPI to call to confirm freight charges. If customer does not request confirmation, UPI will ship the express order.

Drop Shipments:

All drop shipment orders will be assessed a \$10.00 processing fee. Drop shipment processing fee will be automatically added to the invoice without notice. All drop shipment orders must be faxed in. No freight allowance or prepaid freight will be permitted for any drop shipments, thus, all drop ship orders, regardless of order size, are FOB Carson, CA.

CLAIMS

General Policy:

All claims (Shortage, Mis-Shipped, Damage, Overage, Customer Error & Billing Error) must be submitted to UPI within 3 business days of the receipt of shipment. Claims submitted beyond 3 business days of the receipt of shipment will be voided by UPI.

On all shipments, the person who signs and receives the shipment is responsible for noting on the Bill of Lading, in writing, whether any boxes arrived damaged or shorted. Failure to do so will void all claim rights between all parties. UPI will have no recourse against the trucking company if customer does not note any damages or shortages on the Bill of Lading.

The customers receiving department must count and sign for the exact number of boxes received. Failure to follow the above instructions will void all claim rights between all parties.

Shortages / Mis-Ships / Damages

While UPI strives to fill every order with 100% accuracy, on occasion an item may get shipped in error or get damaged during shipping. In the event this occurs, please follow the process below. Note: This type of claim must be reported to UPI within three (3) business days of receiving the order.

- Contact the United Pacific office to initiate the claim. To make it easy for you we have two acceptable methods for requesting the claim:
 - * By e-mail : returns@uapac.com
 - * By fax : **(310) 638-6287**
 - * **Note: To ensure you receive a timely credit, we cannot accept claim requests by phone.**
- You will be required to provide the following information:
 - * Your business name
 - * Contact name and telephone number (in case we have questions)
 - * Date the order was received

- * A copy of the Packing List / Invoice noting the item number and quantity that was shipped in error or damaged during shipping.
- * Special instructions you have for us.

- UPI will send a return label so you can ship the items back.
- Once we receive the miss-shipped/damaged item(s) a credit will be issued to your account on the next billing cycle.
- Shortages will be credit to the Customers' account, unless customer would like the shortages replaced.

Overages:

UPI strives to provide our customers with the best customer service and products, in turn we would greatly appreciate any help from customer in notifying UPI of any shipping overages. Customers will be offered the option of retaining the merchandise or returning the merchandise to UPI at UPI's expense. If the items are to be returned, an RMA number and return shipping label will be provided.

Customer Errors:

Any item or quantity ordered in error by the customer may be returned by contacting UPI for a RMA No.

- To make it easy for you we have two acceptable methods for requesting the RMA:
 - * By e-mail: returns@uapac.com
 - * By fax: **(310) 638-6287**
 - * **Note: To ensure you receive a timely RMA credit, we cannot accept RMA requests by phone.**
- You will be required to provide the following information.
 - * Your business name
 - * Contact name and telephone number (in case we have questions)
 - * A list of the items number and quantity ordered in error
 - * Special instructions you have for us
- UPI will review the request to ensure the products are within the return period.
- Once we have validated the request, United Pacific will issue an RMA number to the customer. In issuing the RMA approval, the following conditions will apply :
 - * Returned items are subject to a 20% re-stocking fee.
 - * Return shipping costs are the responsibility of the customer.
 - * Items must not have any retail/price sticker on exterior packaging or they will be returned to the customer at customer's expense and no credit given.
 - * Items must be in good condition with original packaging intact or they will be returned to the customer at customer's expense and no credit given.
 - * Allow up to 30 days for the credit to be issued from the time the returned items are received.

Billing Errors:

Billing errors should be reported to UPI within 3 business days of invoice receipt. Customers are asked to provide the invoice number, part number, and quantities in question. Once verified, UPI will issue a credit or an invoice for the difference in billing error.

WARRANTY POLICY / RETURNS

IMPORTANT: PLEASE REVIEW CAREFULLY

WARRANTY POLICY

General Policy:

UPI offers a NO HASSLE WARRANTY RETURN policy to all our customers. Warranty claims can only be submitted through an authorized UPI Distributor. UPI warranty is not transferable and applies to the original installation and purchase only. In no event shall UPI be liable for incidental or consequential damages, nor shall UPI be liable for any claims or damages arising out of or connected with the UPI warranty exceed the purchase price of the products. There are no warranties, expressed or implied (including any warranty of merchantability or fitness) that extend beyond this warranty. The warranty does not apply to costs associated with the loss of use of the product, loss of time, inconvenience, commercial loss, incidental or consequential damages. UPI reserves the right to alter the designs of products without assuming any obligation to modify previously manufactured products and will only replace warranted products with redesigned products.

Warranty does not apply to merchandise that has been drilled, cut, welded, modified in any way or installed contrary to normal installation and usage. In addition, UPI cannot be held liable for damages caused by road hazards, accidents, misuse, neglect, abuse or corrosive environments including acid washes and highway snow/ice chemicals which can cause discoloration and corrosion in aluminum, chrome, stainless steel and light products. UPI reserves the right to credit returned merchandise at the initial purchase price or at the current selling price, which price ever is lower.

Aluminum / Chrome / Stainless Steel Products:

All aluminum, chrome, and stainless steel products carry a limited 6 month warranty (from invoice date) against defects in material or workmanship.

Lighting Products:

Incandescent

All incandescent lighting products carry a limited 12 month warranty (from invoice date) against defects in material or workmanship. The limited 12 month warranty does not apply to several applications, such as, buses, construction equipment, and off road vehicles.

LED

Please refer to the Master Lighting Product Catalog for more detail.

RETURNS

General Policy:

All returns must be authorized by UPI. All return requests must be faxed or e-mailed (returns@uapac.com) A RMA number (Return Merchandise Authorization Number) will be provided. Returns not possessing a valid RMA number are subject to rejection and will be returned to sender at the customer's expense.

All customers are encouraged to use the Warranty RMA Claim Form.

Defective Goods / Warranty Return:

UPI offers our customers a No Hassle Warranty Return. Please follow the instructions below for requesting a RMA for defective goods:

1. If any warranty issues occur, simply contact the UPI for RMA number To make it easy for you we have two acceptable methods for requesting the RMA:

* By e-mail: returns@uapac.com

* By fax: (310) 638-6287

* **Note: To ensure you receive a timely RMA credit, we cannot accept RMA requests by phone.**

2. You will be required to provide the following information:

* Your business name

* Contact name and telephone number (in case we have questions)

* A list of the defective item number and quantity with the nature/reason of the defect

* Special instructions you have for us

* The enclosed fax form may be used for your convenience to request an RMA

3. UPI will review the request to ensure the products are within the stated warranty period.

4. Once we have validated the warranty items, a RMA confirmation, listing the items and cost will be faxed to the customer within 3 business days. UPI will process the credit to your account within 30 days.

Note: There will be no need to return the warranty product to us. However, from time to time, UPI may require some warranty products to be shipped back so we may analyze the cause of the failure. All warranty products that are required to be shipped back will be freight prepaid by UPI.

Stock Return

United Pacific Industries encourages all customers to regularly monitor the sales volume and stock level of their inventory items. As sales trends may slow the movement of specific items, our hope is that those items are featured as "close-out specials" as to minimize stock returns. We also understand that the customer, from time to time, may accumulate over-stock items and desire to return those. Therefore, we have adopted the following policy below.

NOTE:

* Items must have been purchased by the dealer requesting the stock return.

* Items must have been purchased within the preceding 12 months.

* Items that have been discontinued will not be considered for return.

1. Contact the United Pacific office for RMA number We have 2 acceptable methods for requesting the RMA:

By e-mail : returns@uapac.com

By fax : (310) 638-6287

Note: To ensure you receive a timely RMA credit, we cannot accept RMA requests by phone.

2. You will be required to provide the following information:

* Your business name

* Contact name and telephone number (in case we have questions)

* A list of defective items: Item numbers and quantity of each

* Special instructions you have for us

3. Your claim will be reviewed within 5 business days and you will be contacted by your sales representative who will discuss solutions to liquidate these slow moving items.

4. In the event United Pacific and the customer agree to a credit in lieu of returning the items, this credit will be issued within 10 business days.

5. In the event items are returned by the customer, United Pacific will issue an RMA number to the customer. In issuing the RMA approval, the following conditions will apply:

* Returned items are subject to a 20% re-stocking fee.

* Return shipping costs are the responsibility of the customer.

* Items must not have any retail/price sticker on exterior packaging or they will be returned to the customer at customer's expense and no credit given.

* Items must be in good condition with original packaging intact or they will be returned to the customer at customer's expense and no credit given.

RETURNS / CATALOGS / DISCLAIMER

IMPORTANT: PLEASE REVIEW CAREFULLY

* Allow up to 30 days for the credit to be issued from the time the returned items are received

6. Stock returns may be requested throughout the year and are subject to a maximum of 5% of prior year annual purchases.

Closeout/Discontinue Items:

UPI will not warranty or accept returns on Closeout/Discontinue items.

Procedure:

An inventory of the merchandise being returned must accompany each return. The RMA number should be prominently displayed on each carton/box.

All Returns must be returned freight prepaid.

Ship Returns to:

United Pacific Industries
Attn: Returns Department
1751 E. Del Amo Blvd
Carson, CA 90746

RMA's:

Outstanding RMA's will be automatically cancelled if not used within 30 days of issuance.

CATALOGS

General Policy:

UPI will send a set of catalogs and price lists upon the arrival any new catalogs and price list. Included in the mailing will be a Catalog Order Form in which customers can request additional copies.

Catalog/CD Request:

UPI provides additional catalogs/CD's to our customers free of charge. Customer must submit their request on a UPI Catalog Order Form or add the request to their regular restocking order. Requests for additional catalogs/CD's should be submitted along with the regular restocking orders to avoid additional freight charges. Due to the availability of catalogs/CD's, customer's request may be limited to certain quantity. Catalogs/CD's will be shipped along with the customers' order. Customer may request the catalogs be shipped separately, but customer will be responsible for the freight charge.

Picture Request

All UPI item pictures are taken professionally by our marketing department. Item pictures can be downloaded online at www.uapac.com. Item pictures not posted online can be requested by sending an email to e-mail graphic@uapac.com. All picture requests must state the item no and the format of the picture file, i.e jpeg or high resolution. UPI has over 20,000 SKU's and therefore does not have a CD with all the items.

DISCLAIMER

United Pacific Industries reserves the right to amend or update our Policies & Procedures without notice.

RMA FORM SAMPLE



DEFECTIVE GOODS / WARRANTY CLAIM FORM

Date: _____

Company Name: _____

Address 1: _____

Address 2: _____

City, State, Zip: _____

Contact Name: _____

List defective items below:

Item #	Quantity	Description	Reason for Defect
1			
2			
3			
4			
5			
6			
7			
8			
9			
10			

Any special notes / instructions for United Pacific (list here): _____

File name/Item no: _____
 By email - returns@uapac.com
 By fax - (310) 638-3337

Note: we cannot accept any price request

Internal Use Only

Date Received: _____ Final RMA _____
 RMA Approval Date: _____ Credit Amount: _____
 RMA Number: _____ Approved By: _____

CATALOG ORDER FORM SAMPLE



UNITED PACIFIC CATALOG ORDER FORM

Date: _____

Company Name: _____

Address 1: _____

Address 2: _____

City, State, Zip: _____

Contact Name: _____

Item #	Description	Quantity	Total
1	UP INTERIOR PRODUCT CATALOG - KENWORTH, CD ROM EDITION (Limit 5 per order)		
2	UP INTERIOR PRODUCT CATALOG - PETERBILT, CD ROM EDITION (Limit 5 per order)		
3	UP HEADLIGHT LIGHTING PRODUCT CATALOG, 1 ST EDITION (Limit 5 per order)		
4	UP INTERNATIONAL PRODUCT CATALOG, 1 ST EDITION (Limit 5 per order)		
5	UP INTERIOR PRODUCT CATALOG - KENWORTH, 2 ND EDITION (Limit 5 per order)		
6	UP LED REAR LIGHT BAR CATALOG, 1 ST EDITION (Limit 5 per order)		
7	UP LED LIGHTING PRODUCT CATALOG, 1 ST EDITION (Limit 5 per order)		
8	UP MASTER LIGHTING CATALOG, 2 ND EDITION (Limit 5 per order)		
9	UP MINI KENWORTH INTERIOR PRODUCT CATALOG (Limit 50 per order)		
10	UP MINI 2009 PETERBILT INTERIOR PRODUCT CATALOG (Limit 50 per order)		
11	UP MULTI COVER & WHEEL PRODUCT CATALOG (Limit 5 per order)		
12	UP INTERIOR PRODUCT CATALOG - PETERBILT, 2 ND EDITION (Limit 5 per order)		
13	UP 1200 2009 UP NEW ITEM SUPPLEMENT, ANNUAL (Dec. 07 - Dec. 09 New Items) (Limit 5 per order)		
14			
15			
16			
17			
18			
19			
20			

Any special notes / instructions for United Pacific (list here): _____

Please read the following policies for ordering catalogs:
 A) All orders for brochures, catalogs, and price books will be shipped with the customers' next regular order.
 B) If you want your brochures to ship independent of your next order, extra shipping fees will be applied and billed to your account. Please approve the shipping fees by providing a signature below.

Signature _____

PRODUCT INDEX

Item No.	Page No.	Item No.	Page No.	Item No.	Page No.	Item No.	Page No.	Item No.	Page No.	Item No.	Page No.
10001	2	10031	2	10076P	5	10124	23	10183	13	10236	4
10002C	2	10031CTP	2	10077	6	10125	23	10184	13	10237	4
10002CP	2	10031P	2	10077P	6	10126	23	10185	13	10240	16
10003	2	10032C	2	10078	6	10127	23	10189	12	10242	16
10003P	2	10033	4	10078P	6	10128	24	10191	13	10248	27
10004	2	10033T	4	10080	3,31,32,33,34	10129	23	10192	13	10250	27
10004C	2	10034B	8,21	10080P	3	10130	23	10193	13	10251	27
10004P	2	10035	3	10081	3,31,32,33,34	10131	22	10194	13	10256	19
10005	2	10035P	3	10081P	3	10132	22	10195	13	10257	19
10005P	2	10038	4	10082	6	10133	22	10196	13	10258-1B	20
10006	2	10039	4	10082P	6	10134	22	10197	17	10258B	19,20
10006P	2	10040	4	10083	3	10136	23	10198	17	10259	9
10007	8,21	10041	4	10083P	3	10137	23	10199	17	10260	19
10007B	8,21	10043	2	10084	5	10138	23	10200	16	10260-1	19,20
10008	2	10043P	2	10084B	5	10139	22	10201	16	10261	19
10008P	2	10044	2	10085	9	10140	23	10201C	16	10262	19
10009	2	10044P	2	10086	6	10141	11	10202	16	10263	19
10009P	2	10045	5	10086P	6	10146	12	10202C	16	10263-1	19,20
10010	3	10045B	5	10087	6	10146C	12	10203	16,23,24,27	10264	19
10010P	3	10046	5	10088	6	10147	12	10203C	16	10264-1	19,20
10011	6	10046B	5	10089	5	10147C	12	10204	16	10264-2	21
10011B	6	10047	5	10090	6	10148	24	10205	16	10265	7
10012	3	10047B	5	10090P	6	10149	12	10206	16,23,24	10266	19
10012P	3	10048	2	10091	6	10149C	12	10207	18	10267-1B	20
10013	8,21	10049	5	10091P	6	10150	12	10207C	18	10267B	19,20
10013B	8,21	10049B	5	10092	6	10150C	12	10209	18	10268B	20
10014B	8,21	10057	5	10092P	6	10152	23	10209P	18	10269B	20
10015	3	10057B	5	10093	6	10153	23	10210	25	10270B	20
10015C	3	10058	5	10093P	6	10154	11	10211	25	10271B	20
10015CP	3	10058B	5	10094	12	10155	13	10212	27	10272	19
10015P	3	10059	5	10094C	12	10156	13	10213	27	10272-1	21
10017	3	10059B	5	10099	11	10157	3	10214	22,23,24,25,27,30	10273	20
10017P	3	10060	5	10100	11	10158	11			10274	20
10018	3	10060B	5	10101	12	10160	11	10215	22,23,24,25,27,30	10279	20
10018P	3	10061	5	10102	15	10161	11			10280	20
10019	3	10061B	5	10103	13	10161-1	11	10216	25	10296B	20
10019P	3	10062	5	10104	13	10161-2	15	10217	27	10297B	20
10020	4	10062P	5	10105	12	10162	11	10218	22,23,24,25,27,30	10298B	20
10021	4	10063	5	10106	12	10166	12			10299B	20
10021P	4	10064	8,21	10106C	12	10167	12	10219	18	10563	8,21
10022	4	10064B	8,19,21	10107	11	10168	12	10219P	18	10563B	8,21
10022P	4	10065	5	10110	13	10169	12	10220	22,23,24,25,27,30	10564	8,21
10023	4	10065P	5	10111	11	10169C	12			10564B	8,21
10023P	4	10066	5	10113	18	10170	17	10221	27	10566B	7
10024	4	10066P	5	10114	18	10171	17	10222	25	10567B	7
10024P	4	10067	5	10115	18	10172	17	10223	25	10568B	7
10025	4	10067P	5	10116	18	10173	13	10224	27	10569	8
10025P	4	10068	6	10117	6	10174	13	10225	27	10569B	8,21
10026	4	10068P	6	10117B	6	10175	13	10226	27	10570	7
10026P	4	10069	5	10118	12	10176	13	10227	16	10570B	7
10027	4	10070	7	10118C	12	10177	11	10228	16	10573	8
10027T	4	10071	7	10119	12	10178	11	10229	16,23,24,27	10573B	8
10028	4	10073	7	10119C	12	10179	11	10232	16	10574	8
10028T	4	10075	5	10121	23	10180	13	10233	16	10574B	8
10030	4	10075B	5	10122	23	10181	13	10234	18	10575	8
10030T	4	10076	5	10123	23	10182	13	10235	4	10575B	8

Item No.	Page No.	Item No.	Page No.	Item No.	Page No.	Item No.	Page No.	Item No.	Page No.	Item No.	Page No.
10576	8	10761	7	11130	17	20207	18	21211	26	90052	15
10576B	8	10761B	7	11131	17	20302	31	21212	28		
10577	8	10762	7	11132	17	20303	33	21213	28		
10577B	8	10762B	7	11133	17	20305	31	21214	26,28,30		
10578	8	10763	7	11134	17	20306	33	21215	26,28,30		
10578B	8	10763B	7	11135	17	20308	31	21216	26		
10579	8	10764	7	11136	17	20309	33	21217	28,33		
10579B	8	10764B	7	20094	12	20311	31	21218	26,28,30,		
10580	8	10765B	7	20098	11	20312	33		33,34		
10580B	8	10766	7	20101	12	20313	33	21219	26,28,30		
10581	8	10766B	7	20105	12	20314	33	21220	29,33,34		
10581B	8	10767B	7	20106	12,31,32	20315	31	21220-1	29		
10582	8	10768	7	20108	11	20317	31	21221	28		
10582B	8	10768B	7	20109	11	20348	31,32	21222	26		
10590	8	10769	7	20111	11	20349	31,32	21223	26		
10590B	8	10769B	7	20116	32	20350	32	21224	28		
10591	8	10770	7,21	20117	32	20351	31,32	21225	28		
10591B	8	10770B	7,21	20118	12	20352	31,32	21226	28		
10592	8	10771	6	20119	12	20353	31,32	21227	28		
10592B	8	10771B	6	20120	12	20354	33,34	21228	28		
10593	8	10772	6	20121	12	20355	33,34	31354	35		
10593B	8	10772P	6	20122	12	20356	33,34	31358	35		
10594	8	10773	9	20123	12	20357	33,34	31359	35		
10594B	8	10774B	6	20124	13	20358	31,33,34	31368	35		
10595	8	10775B	9	20125	13	20359	33,34	31369	35		
10595B	8	10776B	9	20126	13	21100	14	31373	35		
10596	8	10777B	9	20127	13	21101	14	31374	35		
10596B	8	10778	8,21	20130	13	21102	14	31375	35		
10597	8	10778B	8,21	20131	13	21103	14	31376	35		
10597B	8	10779	7,21	20146	12	21104	14	31378	35		
10598	8	10779B	7,21	20147	12	21105	14	31379	35		
10598B	8	10780	8,21	20149	12	21106	17	31380	35		
10599B	8	10780B	8,21	20150	12	21107	17	31381	35		
10700	2	10781B	8,21	20155	13	21108	17	31382	35		
10700P	2	11100	14	20156	13	21110	14	31387	35		
10710B	15	11101	14	20158	11	21111	14	31388	35		
10720	15	11102	14	20159	11	21112	14	31390	35		
10721	15	11103	14	20170	17	21113	14	70084	10		
10723	15	11104	14	20171	17	21114	14	70086	10		
10724B	15	11105	14	20172	17	21115	14	70086-1	10		
10725B	15	11106	17	20173	13	21116	14	70088	10		
10726B	7	11107	17	20174	13	21117	14	70088-1	10		
10749B	10	11108	17	20175	13	21118	14	70090	10		
10750	6	11110	14	20176	13	21119	14	70191	10		
10750B	6	11111	14	20182	16	21120	14	70191-1	10		
10751	6	11112	14	20188	16	21121	14	70192	10		
10751B	6	11113	14	20189	16	21122	14	70192-1	10		
10752	6	11114	14	20190	16,28	21123	14	70193	10		
10752B	6	11115	14	20191	13	21124	14	70193-1	10		
10753B	6	11116	14	20192	13	21125	14	70196	10		
10754	6	11117	14	20193	13	21126	14	70196B	10		
10754B	6	11118	14	20194	13	21127	14	70197	10		
10755	6	11119	14	20195	13	21128	17	70197B	10		
10755B	6	11120	14	20196	13	21129	17	70251	10		
10756	6	11121	14	20197	17	21130	17	70251-1	10		
10756B	6	11122	14	20198	17	21131	17	70601B	29		
10757	6	11123	14	20199	17	21132	17	70607	29		
10757B	6	11124	14	20201	16	21133	17	70609	29		
10758B	6	11125	14	20202	16	21134	17	70621B	29		
10759	6	11126	14	20203	16,28	21135	17	70627	29		
10759B	6	11127	14	20204	16	21136	17	70628	29		
10760	7	11128	17	20205	16	21209	28	90007	9		
10760B	7	11129	17	20206	16	21210	26	90008	9		



www.uapac.com

1751 East Del Amo Blvd, Carson, CA 90746

Tel: (310) 638-5988 / Fax: (310) 638-6287

Toll Free: (800) 790-6988

sales@uapac.com



Know It First. Follow Us on FACEBOOK
Type "UNITED PACIFIC INDUSTRIES"

UCNW2

NUT COVER AND WHEEL PRODUCT
CATALOG - 2ND EDITION



710270095155